

CIERRAPUERTAS

ABATIBLES: Cierrapuertas
Espluges



DESCRIPCIÓN

Estándar bloqueo 90°



REFERENCIA
1R - 2R - 3R - 10R 1C - 2C - 3C - 10C 1CI - 2CI - 3CI - 10CI 1E - 2E - 3E - 10E

Sin retención a 90°



SR

Variación grados (máximo 130°)

VG

CARACTERÍSTICAS

R



Regleta
Strip Pivot

C



Cuadrillo 16/19
Square Pivot 16/19

CI



Cuadrillo 13/16
Square Pivot 13/16

E



Europeo
European Pivot

FUERZA 1:

Ancho de la puerta: 95 cm a 110 cm, alto 230 cm.
Peso máximo aconsejable de la puerta: 80 kg.
Fuerza máxima aproximada de retención: 43 N.

FUERZA 2:

Ancho de la puerta: 80 cm a 95 cm, alto 230 cm.
Peso máximo aconsejable de la puerta: 70 kg.
Fuerza máxima aproximada de retención: 36 N.

FUERZA 3:

Ancho de la puerta: menos de 80 cm, alto 230 cm.
Peso máximo aconsejable de la puerta: 55 kg.
Fuerza máxima aproximada de retención: 35 N.

FUERZA 10:

Ancho de la puerta: 110 cm a 125 cm, alto 230 cm.
Peso máximo aconsejable de la puerta: 95 kg.
Fuerza máxima aproximada de retención: 43 N.

DESCRIPCIÓN

Cierrapuertas standard
bloqueo 90°

G75R regleta



REFERENCIA

G75R

G75R cuadradillo
16/19



G75C

CARACTERÍSTICAS

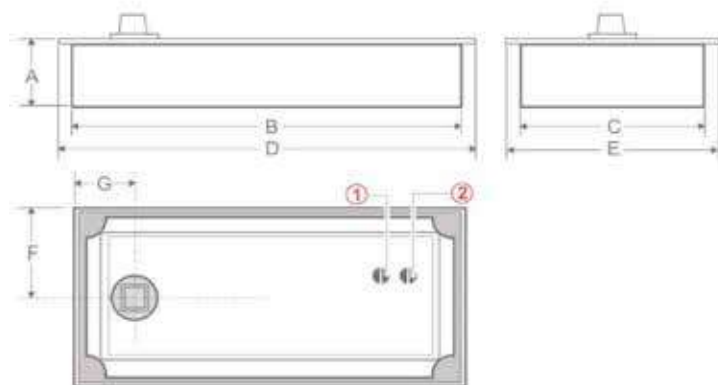
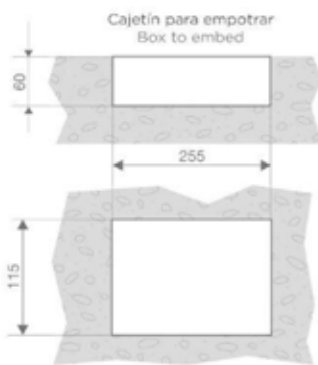

A	B	C	D	E	F	G	Ancho máx. puerta Max. width door (mm)	Peso máx. puerta Max. weight door (kg)
55	250	110	270	135	55	55-65	1100	100

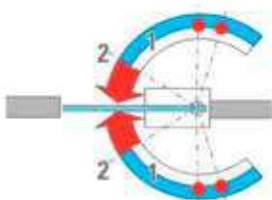

1. Velocidad de aproximación de 90° a 25°.
2. Velocidad de cierre de 25° a 0°.

CIERRAPUERTAS

ABATIBLES: Cierrapuertas
SERIE FS



DESCRIPCIÓN

Cierrapuertas suelo Leva
R regleta



REFERENCIA

FS1100

Cierrapuertas suelo Leva
C cuadradiillo 16/19



FS1200

CARACTERÍSTICAS

MEDIDAS / MEASURES							Ancho máx. puerta (mm) Max width door (mm)	Peso máx. puerta (kg) Max weight door (kg)
A	B	C	D	E	F	G		
50	295	105	313	125	52.5	52/57	1100	135

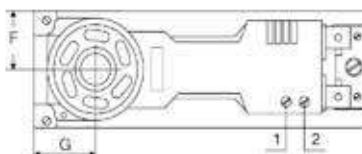
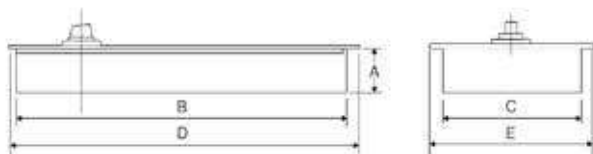
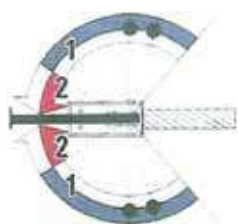

1. Velocidad de aproximación de 90° a 25°.
2. Velocidad de cierre de 25° a 0°.

DESCRIPCIÓN

G100E

Kit Pernio hidráulico + Punto giro + Pernio alto.
Para vidrio de 8 a 13 mm.

Peso máximo: 100 kg.
Anchura máxima de la puerta: 1000 mm.

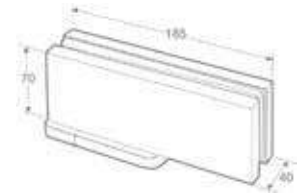
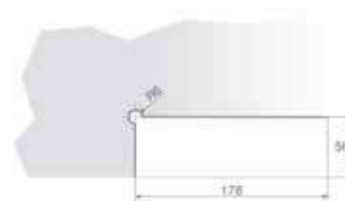
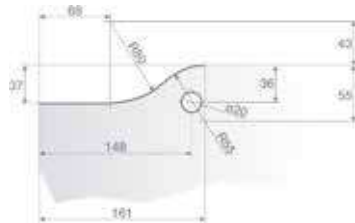
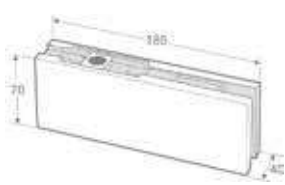

G100

Kit Pernio hidráulico + Punto giro + Pernio alto.
Para vidrio de 10 a 15 mm.

Peso máximo: 115 kg.
Anchura máxima de la puerta: 1250 mm.

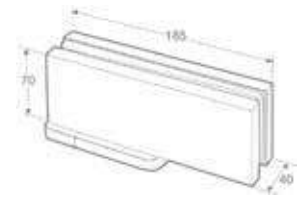
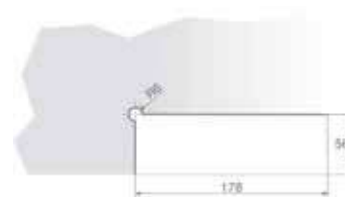
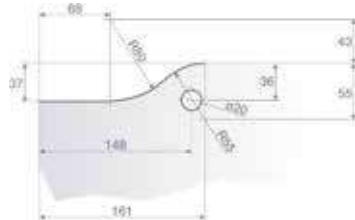
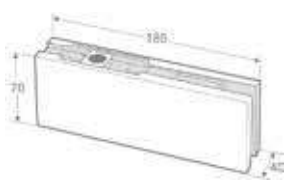

JN-3011

Simple biselada para mampara con posición cerrada a 90°. Para vidrio de 8 y 10 mm.

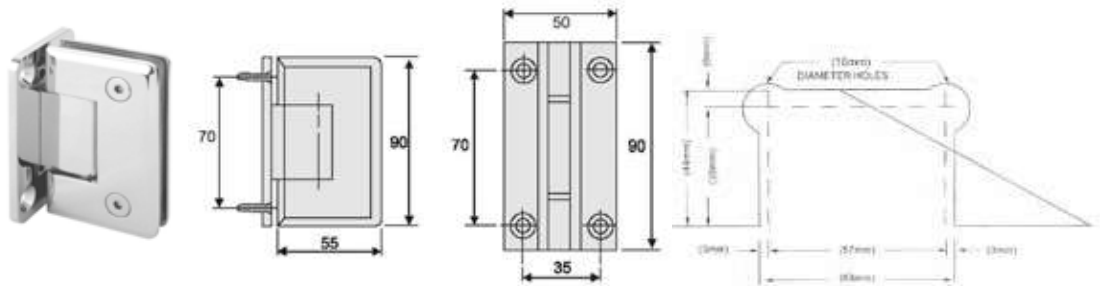

JN-3013

(sujeción lateral)

Simple biselada para mampara con posición cerrada a 90°. Para vidrio de 8 y 10 mm.

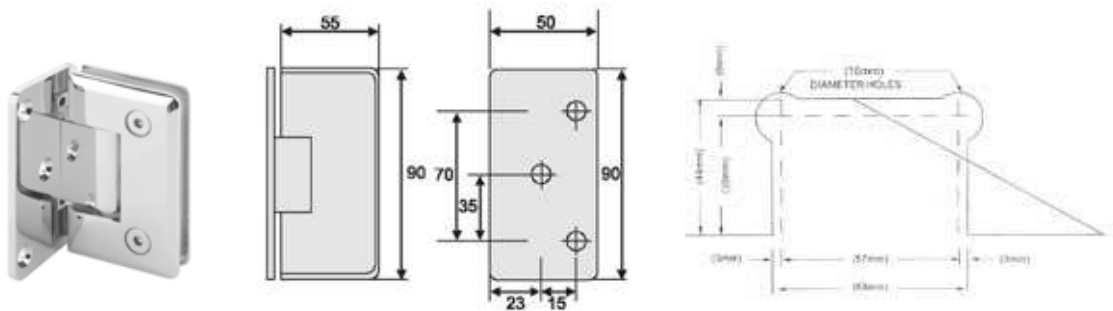

JN-3020

Doble biselada vidrio con posición cerrada a 180°. Para vidrio de 8 y 10 mm.

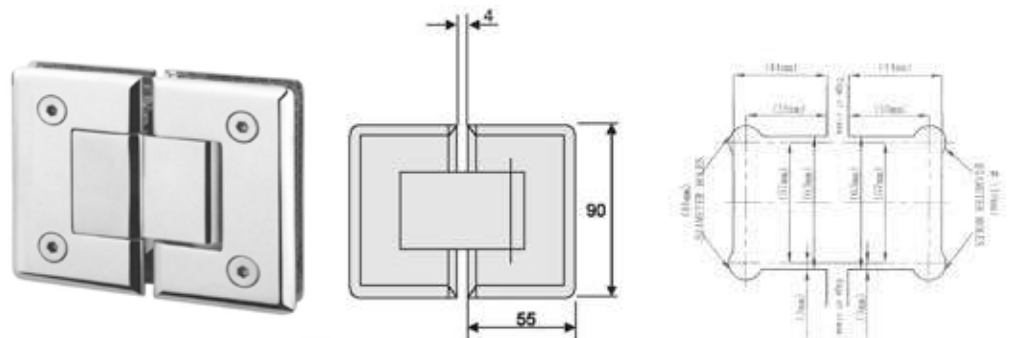

JN-3040

Doble biselada vidrio/ vidrio con posición cerrada 90°. Para vidrio de 8 y 10 mm.

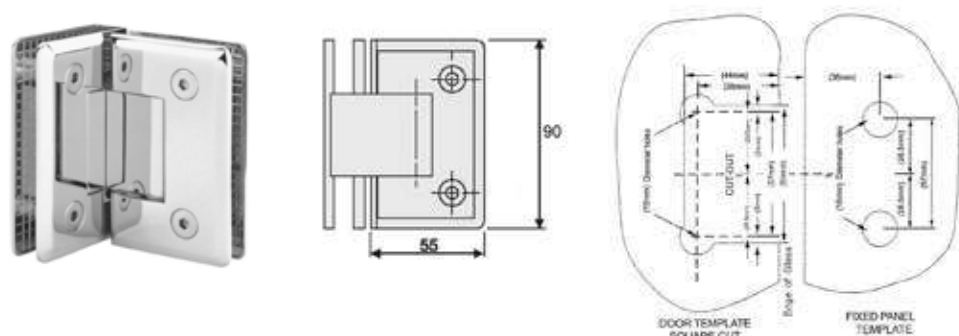

SERIE B1000 Acabados en: cromo satinado

B1000

Bisagra simple biselada.
Para vidrio de 8 a 10 mm.

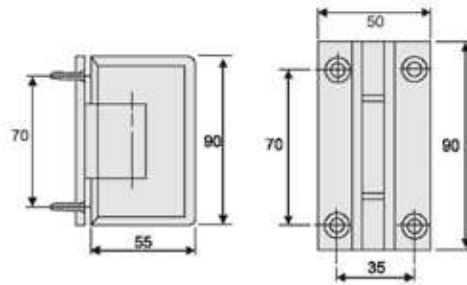

B1004

Bisagra simple esquina
biselada.
Para vidrio de 8 y 10 mm.

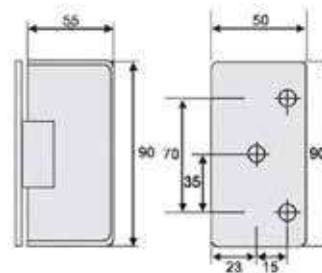

B1003

Doble mismo plano
biselada.
Para vidrio de 8 y 10 mm.

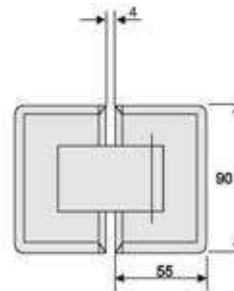

B1001

Bisagra doble 90°
biselada.
Para vidrio de 8 y 10 mm.

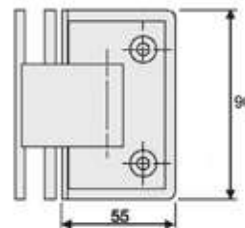

B1005

Hoja batiente biselada.
Para vidrio de 8 y 10 mm.

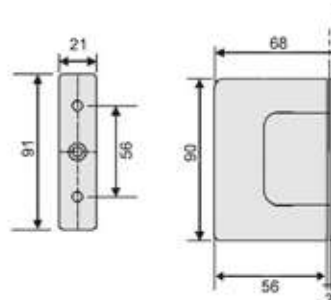

ABATIBLES: Bisagras alineación regulable
DECO

DECO Acabados en: cromo brillo - níquel satinado - cromo negro mate

DECO360

Simple 90°
Para vidrio de 8 y 10 mm.

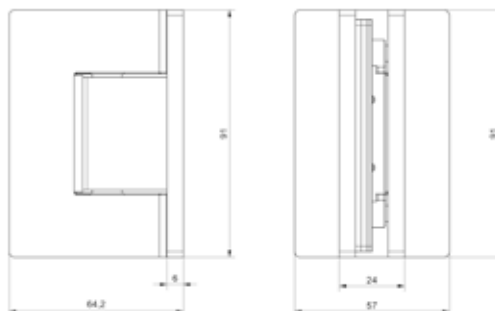

DECO362

Simple esquina 90°
Para vidrio de 8 y 10 mm.

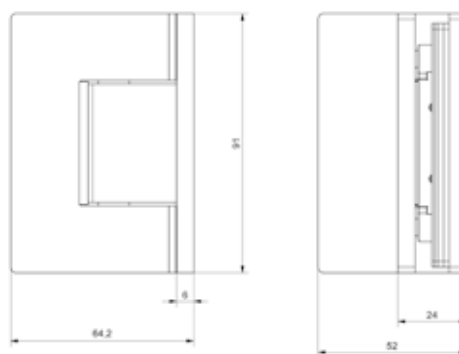

DECO363

Doble mismo plano
Para vidrio de 8 y 10 mm.

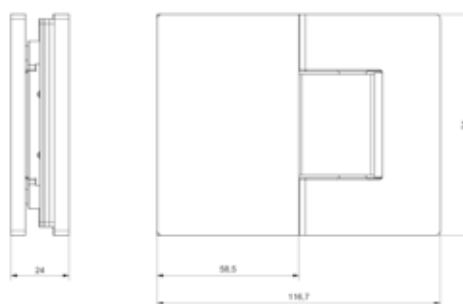

DECO365

Doble 90°
Para vidrio de 8 y 10 mm.



BB Acabados en: cromo brillo - níquel satinado

BB
Simple 90°
Espesor vidrio 8 a 10 mm.

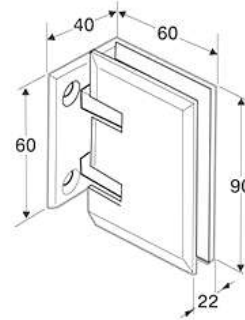

BB135°
Simple 135°
Espesor vidrio 8 a 10 mm.

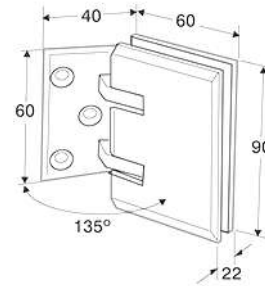

BBD
Doble mismo plano
Espesor vidrio 8 a 10 mm.

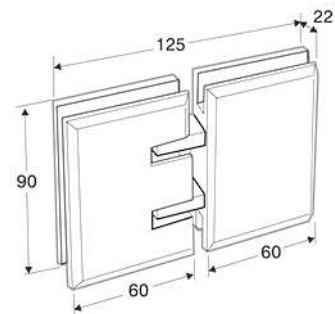

BBD135°
Doble 135° mismo plano
Espesor vidrio 8 a 10 mm.

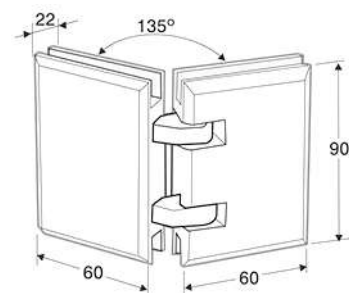

ABATIBLES: Bisagras con retención mecánica

BB

BB Acabados en: cromo brillo - níquel satinado

BBD2

Doble mismo plano con vidrio central.
Espesor vidrio 8 a 10 mm.

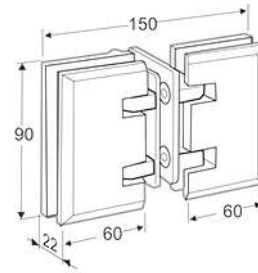

BBD90

Doble 90°.
Tornillos exteriores.
Espesor vidrio 8 a 10 mm.

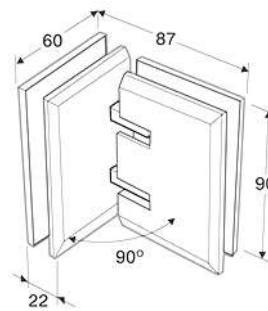

BBD90°-1

Doble 90°.
Tornillos interiores.
Espesor vidrio 8 a 10 mm.

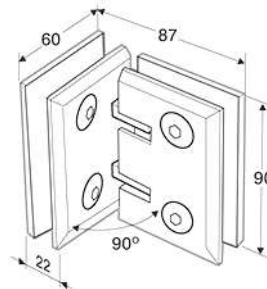

BBE

Simple esquina 90°.
Espesor vidrio 8 a 10 mm.

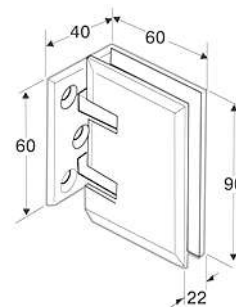

BBP

Doble plegable mismo plano (sin retención).
Espesor vidrio 8 a 10 mm.

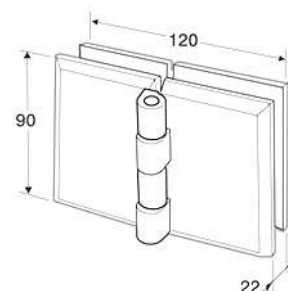

BG18 Acabados en: cromo brillo - níquel satinado - oro - veloux - colores ral - latón brillo

Bisagras **sin retención**
para galce.

Simple 90° para marcos
con galce de 35 a 40 mm
Espesor vidrio 8 a 10 mm.

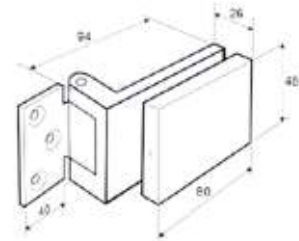

VESTA Acabados en: latón - acero inoxidable AISI/316

360V

Simple 90°.
Espesor vidrio 8-10 mm.

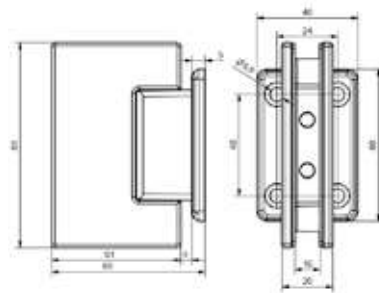

362V

Simple esquina 90°.
Espesor vidrio 8-10 mm.

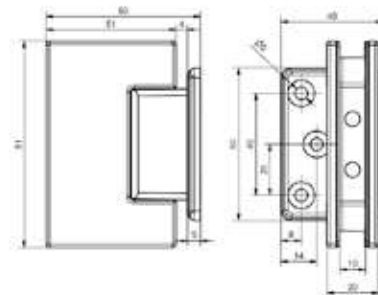

363V

Doble mismo plano.
Espesor vidrio 8-10 mm.

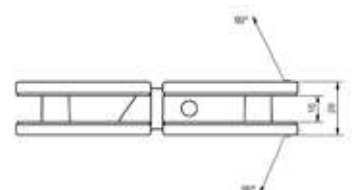
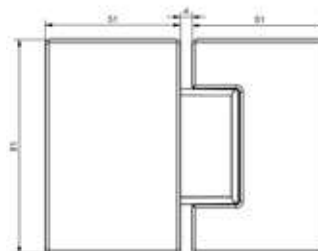

ABATIBLES: Bisagras con retención / Bisagras hidráulicas
VESTA / HIDROBI

VESTA Acabados en: latón - acero inoxidable

365V

Doble 90°
 Tornillos exteriores.
 Espesor vidrio 8-10 mm.

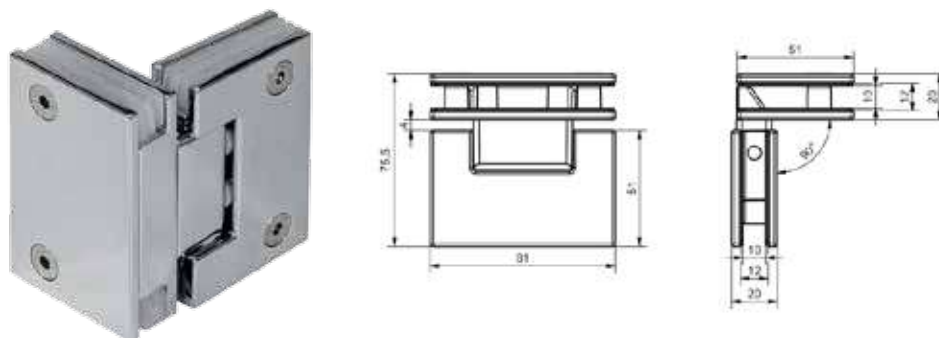

367V

Doble mismo plano con vidrio central.
 Espesor vidrio 8-10 mm.

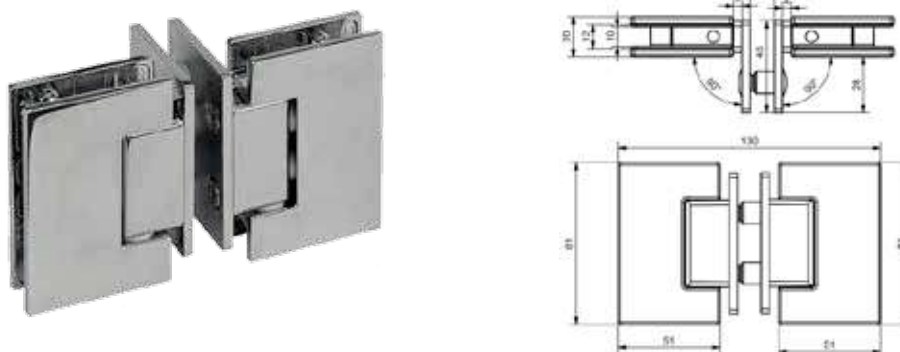

368V

Doble 90°.
 Tornillos interiores.
 Espesor vidrio 8-10 mm.

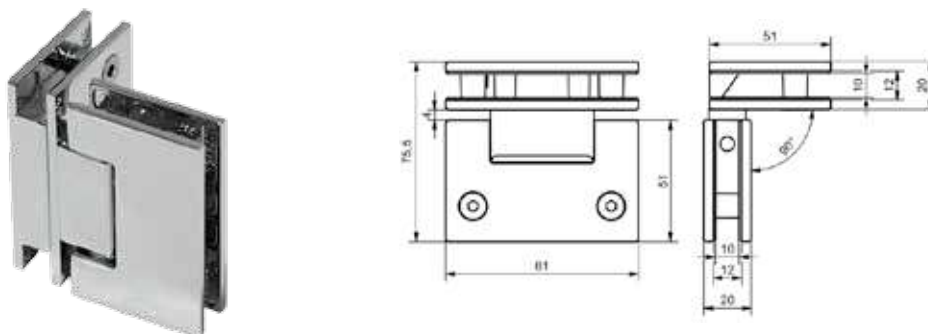

HIDROBI Acabados en: anodizado brillo - anodizado plata mate - anodizado inox

H1101

Base fijación centrada.
 Espesor vidrio 8-10-12 mm, 8+8 mm y 10+10 mm

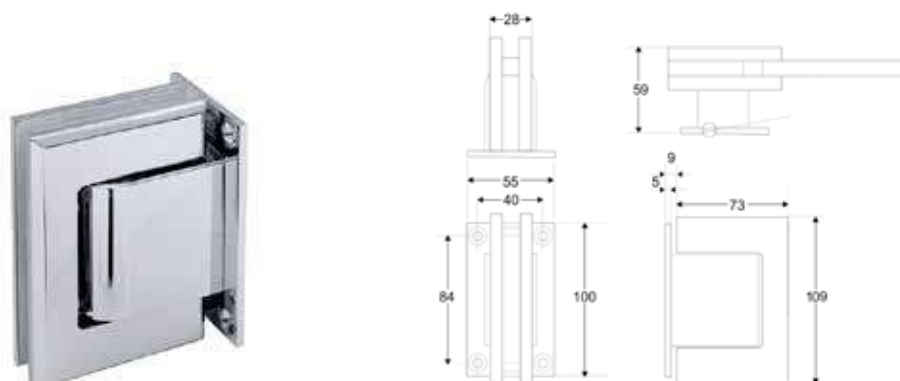

HIDROBI Acabados en: anodizado brillo - anodizado plata mate - anodizado inox

H1102

Base fijación desplazada.
Espesor vidrio 8-10-12 mm,
8+8 mm y 10+10 mm.

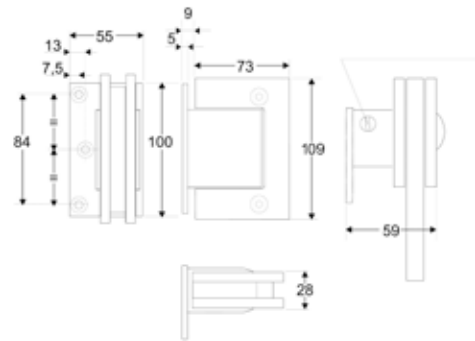

H1103

Base fijación centrada.
Espesor vidrio 8-10-12 mm,
8+8 mm y 10+10 mm.

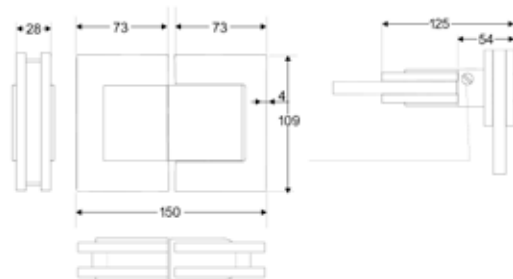

H1201

Base fijación centrada.
Espesor vidrio 8-10-12 mm,
8+8 mm y 10+10 mm.

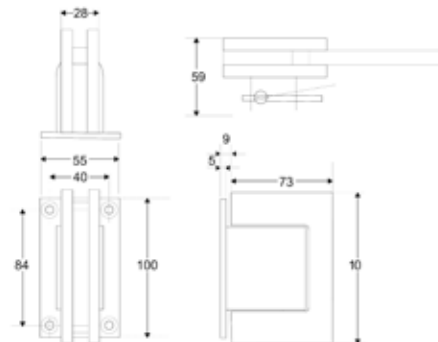

H1202

Base fijación desplazada.
Espesor vidrio 8-10-12 mm,
8+8 mm y 10+10 mm.

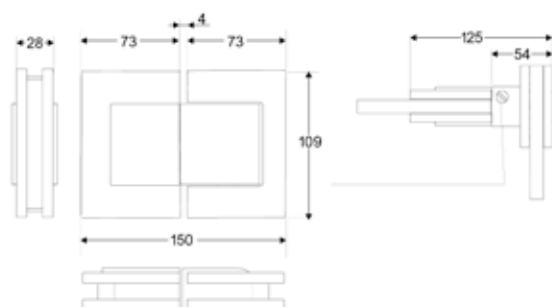

ABATIBLES: Bisagras hidráulicas
HIDROBI / HIDROBI MARK III

HIDROBI Acabados en: anodizado brillo - anodizado plata mate - anodizado inox

H1203

Doble vidrio mismo plano.
 Espesor vidrio 8-10-12 mm,
 8+8 mm y 0+10 mm.

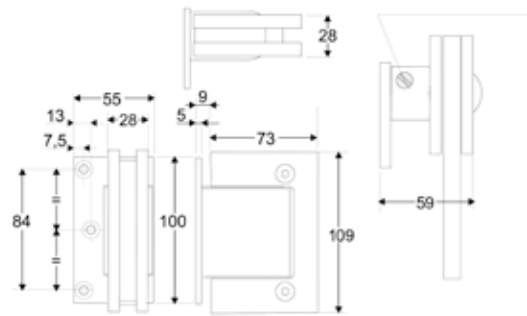

HIDROBI MARK III Acabados en: anodizado brillo - anodizado plata mate - anodizado inox

H2201

Base fijación centrada.
 Espesor vidrio 8-10-12 mm.

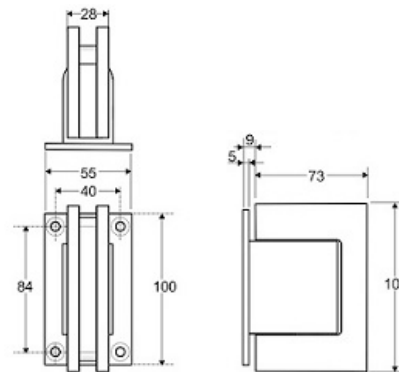

H2202

Base fijación desplazada.
 Espesor vidrio 8-10-12 mm.

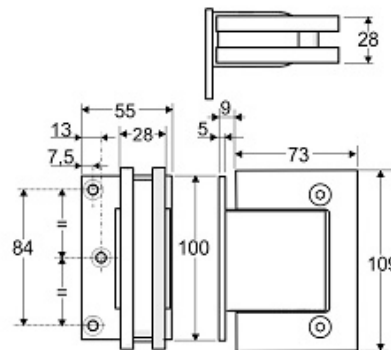

H2203

Doble mismo plano.
 Espesor vidrio 8-10-12 mm.

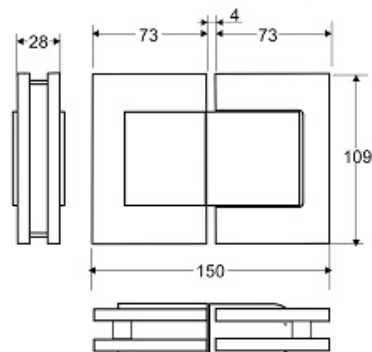

GT Acabados en: inox brillo - inox satinado

DISPONIBLES PARA VIDRIO DE 12 MM

GT900

Punto de giro.
Espesor vidrio 10 mm.

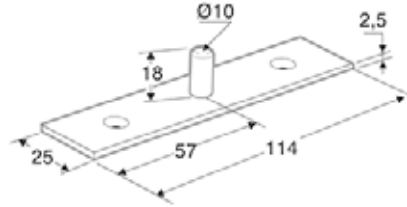

GT901

Pernio alto regulable.
Espesor vidrio 10 mm.

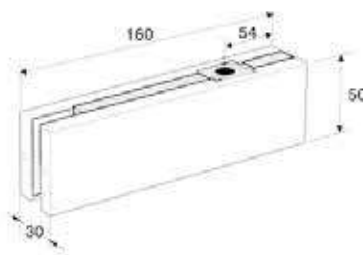

GT901D

Pernio alto regulable desplazable.
Espesor vidrio 10 mm.

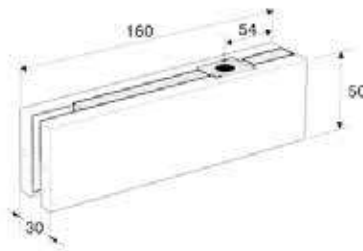

GT902C

Pernio alto regulable cuadrado 16/9.
Espesor vidrio 10 mm.

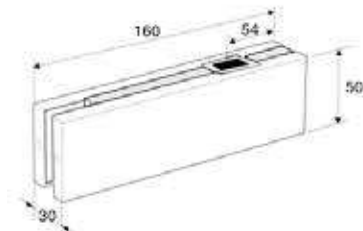

GT902CD

Pernio bajo regulable cuadrado 16/9 desplazable.
Espesor vidrio 10 mm.

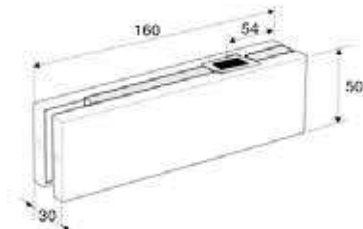

PERNIOS Y HERRAJES PARA TEMPLADO

HERRAJES REGULABLES CON TAPA
GT / MILLENNIUM / N / T

GT Acabados en: inox brillo - inox satinado

DISPONIBLES PARA VIDRIO DE 12 MM

GT902E

Pernio bajo regulable europeo.
Espesor vidrio 10 mm.

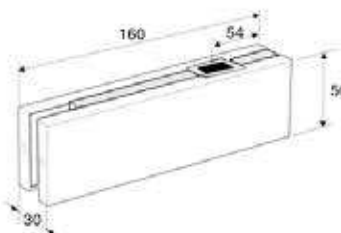

GT902ED

Pernio bajo regulable europeo
desplazable.
Espesor vidrio 10 mm.

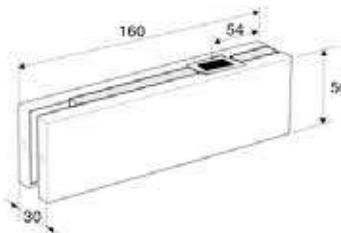

GT902R

Pernio bajo regulable regleta.
Espesor vidrio 10 mm.

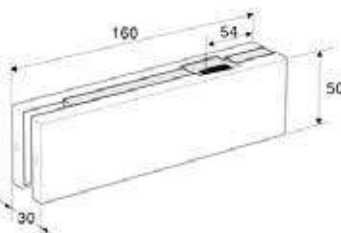

GT902RD

Pernio bajo regulable
regleta desplazable.
Espesor vidrio 10 mm.

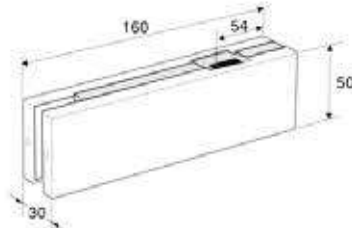

GT903

Punto de giro montante
regulable.
Espesor vidrio 10-12 mm.

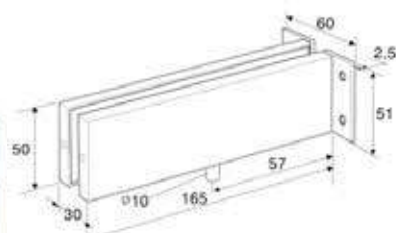

GT Acabados en: inox brillo - inox satinado

DISPONIBLES PARA VIDRIO DE 12 MM

GT903D

Punto de giro montante regulable desplazable.
Espesor vidrio 10 mm.

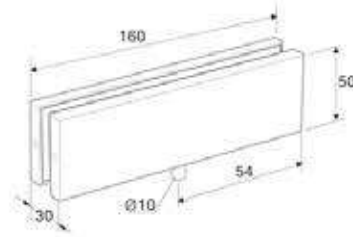

GT904

Punto de giro lateral montante regulable.
Espesor vidrio 10 mm.

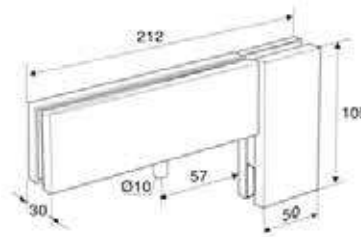

GT905

Punto de giro lateral montante con contrafuerte regulable.
Espesor vidrio 10 mm.

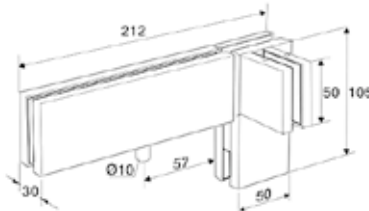

GT906

Unión una luna.
Espesor vidrio 10 mm.

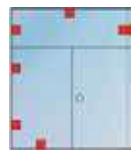
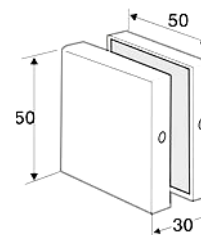

GT907

Unión una luna vértices.
Espesor vidrio 10 mm.

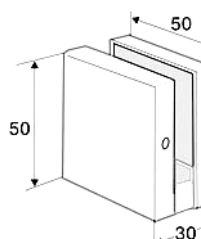

PERNIOS Y HERRAJES PARA TEMPLADO

HERRAJES REGULABLES CON TAPA
GT / MILLENNIUM / N / T

GT Acabados en: inox brillo - inox satinado

DISPONIBLES PARA VIDRIO DE 12 MM

GT908

Unión dos lunas.
Espesor vidrio 10 mm.

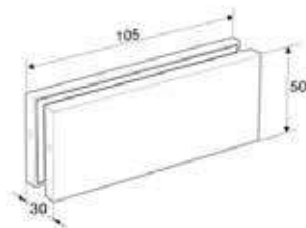

GT909

Unión puerta corredera.
Espesor vidrio 10 mm.

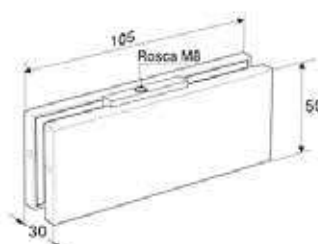

GT910

Unión tres lunas.
Espesor vidrio 10 mm.

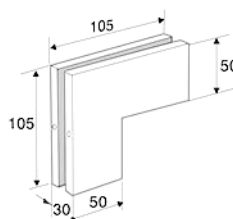

GT911

Unión tres lunas tope.
Espesor vidrio 10 mm.

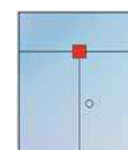
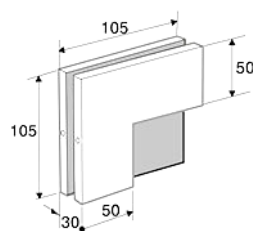

GT912

Unión cuatro lunas.
Espesor vidrio 10 mm.

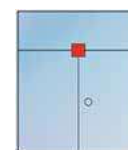
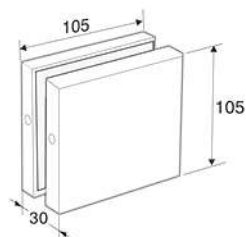

GT Acabados en: inox brillo - inox satinado

DISPONIBLES PARA VIDRIO DE 12 MM

GT913

Unión dos lunas tope.
Espesor vidrio 10 mm.

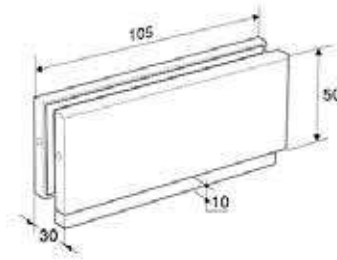

GT914

Unión tres lunas con
contrafuerte.
Espesor vidrio 10 mm.

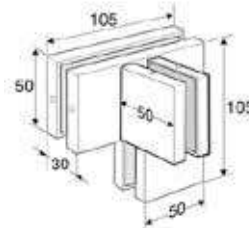

GT915

Unión tres lunas tope con
contrafuerte.
Espesor vidrio 10 mm.

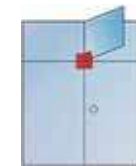
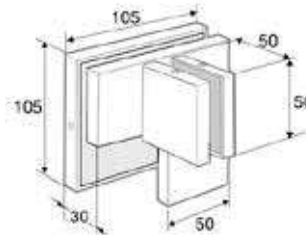

GT916

Unión dos lunas con
contrafuerte.
Espesor vidrio 10 mm.

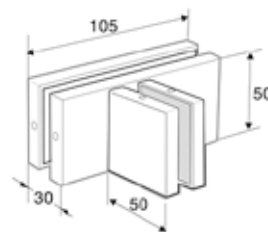

GT917

Unión dos lunas ángulo 90°.
Espesor vidrio 10 mm.

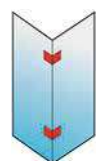
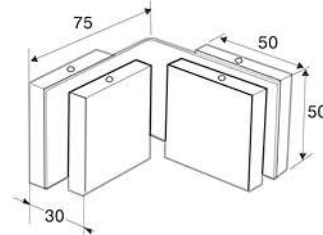

PERNIOS Y HERRAJES PARA TEMPLADO

HERRAJES REGULABLES CON TAPA
GT / MILLENNIUM / N / T

GT Acabados en: inox brillo - inox satinado.

DISPONIBLES PARA VIDRIO DE 12 MM

GT918

Unión dos lunas ángulo 90°
90° suelo/techo.
Espesor vidrio 10 mm.

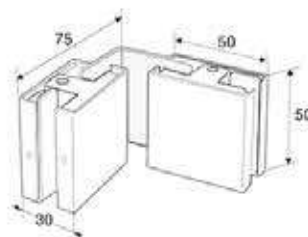

GT919

Unión tres lunas ángulo 90°.
Espesor vidrio 10 mm.

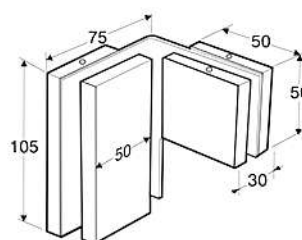

GT920

Unión tres lunas tope
ángulo 90°.
Espesor vidrio 10 mm.

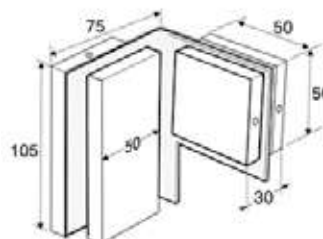

GT921

Unión cuatro lunas ángulo 90°.
Espesor vidrio 10 mm.

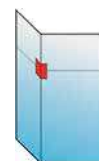
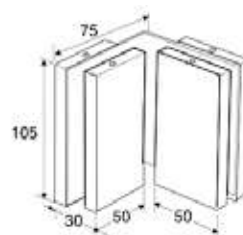

GT922

Punto de giro lateral montante
ángulo 90°.
Espesor vidrio 10 mm.

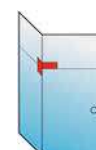

GT Acabados en: inox brillo - inox satinado

DISPONIBLES PARA VIDRIO DE 12 MM

GT923

Punto de giro techillo.
Espesor vidrio 10 mm.

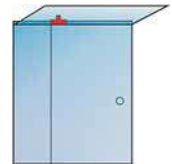
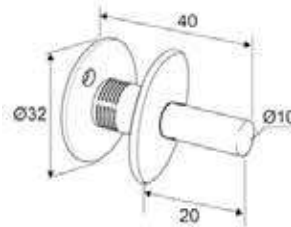

GT924

Unión dos lunas vertical.
Espesor vidrio 10 mm.

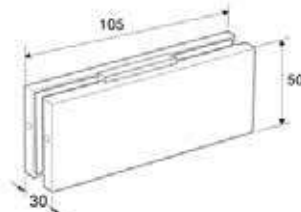

GT925

Unión una luna sin anclaje interior.
Espesor vidrio 10 mm.

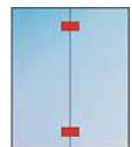
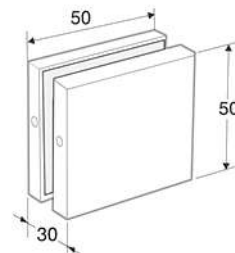

GT926

Punto de giro montante regulable doble en batería puertas.
Espesor vidrio 10 mm.

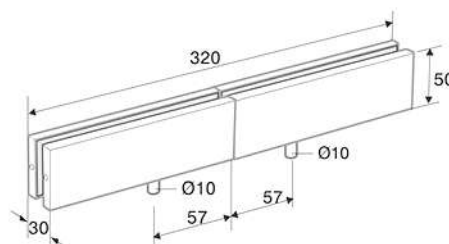

PERNIOS Y HERRAJES PARA TEMPLADO

HERRAJES CON TAPA
GT / MILLENNIUM / N / T

MILLENNIUM Acabados en: inox brillo - inox satinado.

301M

Pernio alto no regulable.
Espesor vidrio 8-10 mm.

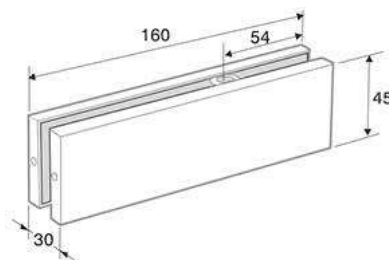

302M

Pernio bajo no regulable
regleta doble.
Espesor vidrio 8-10 mm.

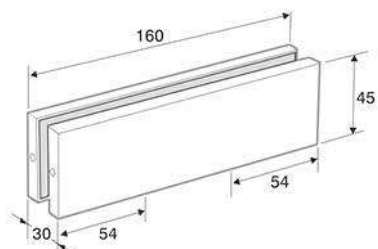

303M

Punto de giro superior
para 301M.
Espesor vidrio 8-10 mm.

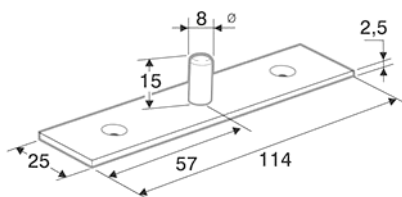

304M

Punto giro montante.
Espesor vidrio 8-10 mm.

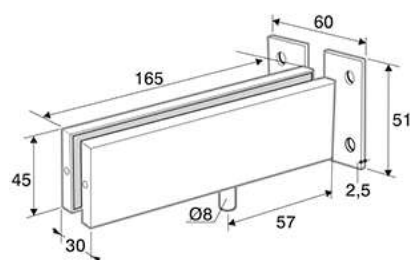

305M

Punto giro montante.
Espesor vidrio 8-10 mm.

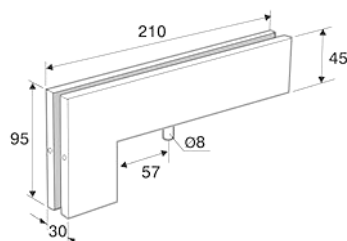

MILLENNIUM Acabados en: inox brillo - inox satinado

306M

Punto de giro lateral
montante ángulo 90°.
Espesor vidrio 8-10 mm.

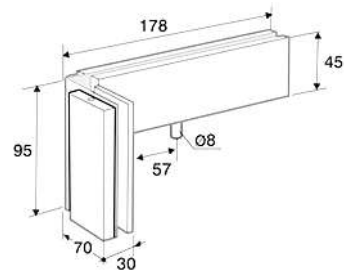

307M

Punto de giro lateral montante
con contrafuerte.
Espesor vidrio 8-10 mm.

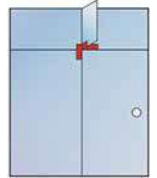
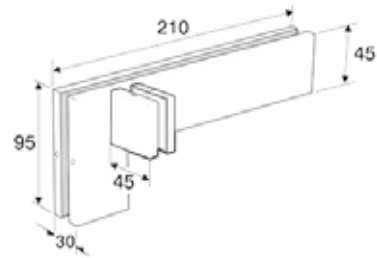

308M

Unión una luna.
Espesor vidrio 8-10 mm.

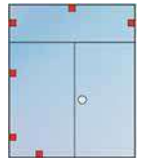
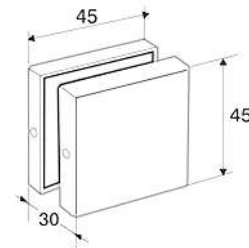

309M

Unión dos lunas.
Espesor vidrio 8-10 mm.

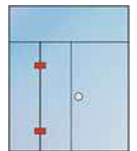
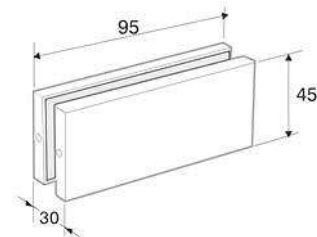

310M

Unión dos lunas tope.
Espesor vidrio 8-10 mm.

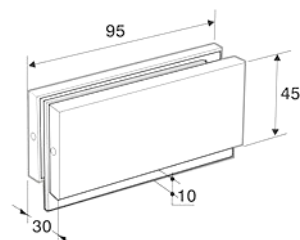

PERNIOS Y HERRAJES PARA TEMPLADO

HERRAJES CON TAPA
GT / MILLENNIUM / N / T

MILLENNIUM Acabados en: inox brillo - inox satinado.

311M

Unión dos lunas ángulo 90°.
Espesor vidrio 8-10 mm.

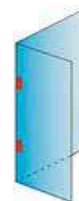
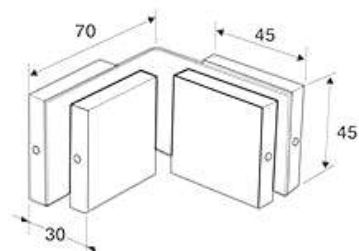

311MS

Unión dos lunas ángulo 90°
suelo/techo.
Espesor vidrio 8-10 mm.

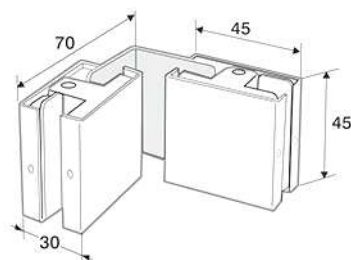

312M

Unión dos lunas con
contrafuerte.
Espesor vidrio 8-10 mm.

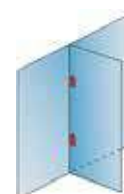
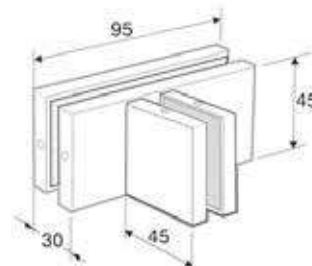

313M

Unión puerta corredera.
Espesor vidrio 8-10 mm.

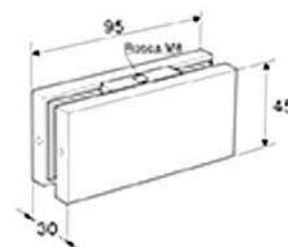

314 M

Punto giro montante.
Espesor vidrio 8-10 mm.

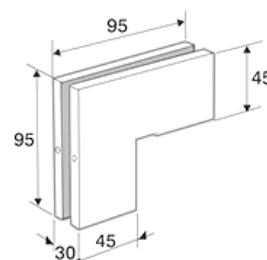

MILLENNIUM Acabados en: inox brillo - inox satinado

315M

Unión tres lunas ángulo 90°.
Espesor vidrio 8-10 mm.

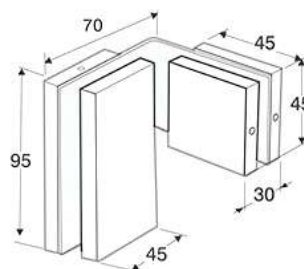

316M

Unión tres lunas con
contrafuerte.
Espesor vidrio 8-10 mm.

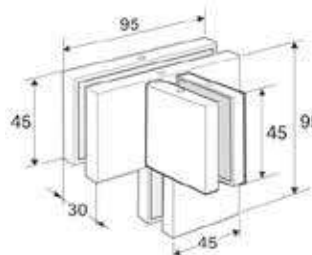

317M

Unión tres lunas tope.
Espesor vidrio 8-10 mm.

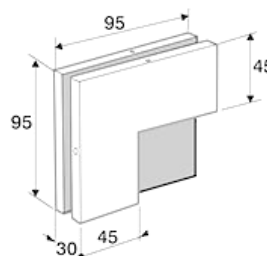

318M

Unión tres lunas tope ángulo 90°.
Espesor vidrio 8-10 mm.

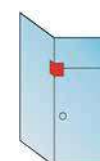
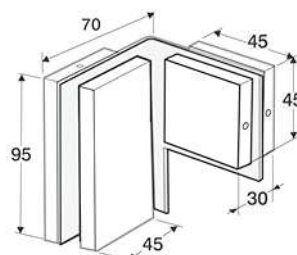

310M

Unión tres lunas tope con
contrafuerte.
Espesor vidrio 8-10 mm.

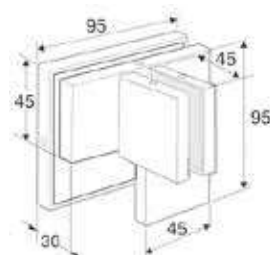

PERNIOS Y HERRAJES PARA TEMPLADO

HERRAJES CON TAPA
GT / MILLENNIUM / N / T

MILLENNIUM Acabados en: inox brillo - inox satinado.

320M

Unión cuatro lunas.
Espesor vidrio 8-10 mm.

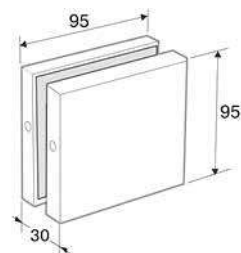

321M

Unión cuatro lunas ángulo 90°.
Espesor vidrio 8-10 mm.

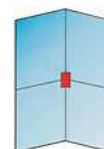
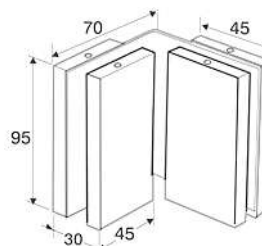

322M

Punto de giro montante desplazable.
Espesor vidrio 8-10 mm.

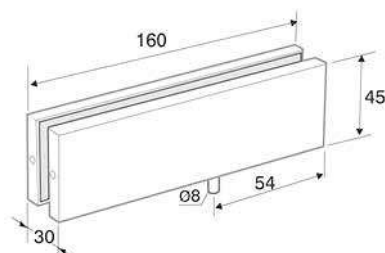

323M

Pernio alto regulable.
Espesor vidrio 8-10 mm.

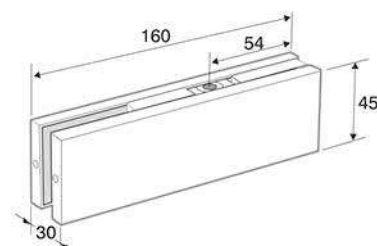

324M

Pernio bajo regulable cuadradillo 16/19.
Espesor vidrio 8-10 mm.

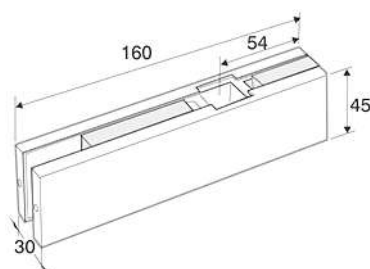

MILLENNIUM Acabados en: inox brillo - inox satinado

325M

Pernio bajo regulable regleta.
Espesor vidrio 8-10 mm.

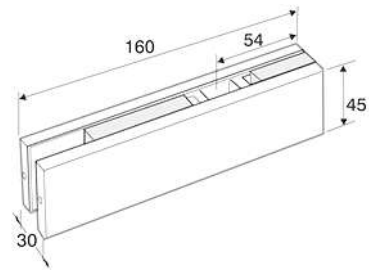

326M

Pernio bajo regulable europeo.
Espesor vidrio 8-10 mm.

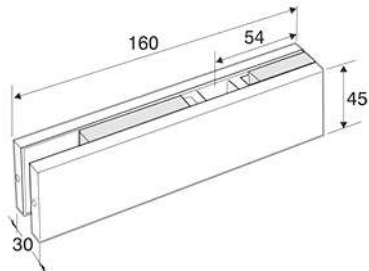

327M

Unión dos lunas vertical.
Espesor vidrio 8-10 mm.

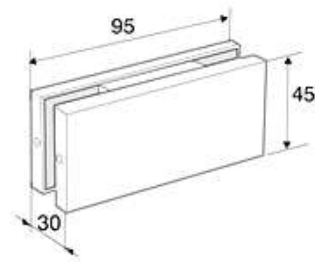

328M

Punto de giro techillo para 301M.
Espesor vidrio 8-10 mm.

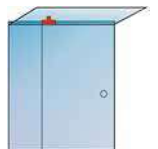
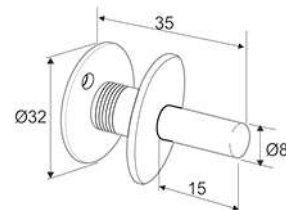

329M

Punto de giro superior para 323M.
Espesor vidrio 8-10 mm.

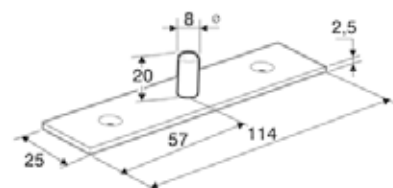

PERNIOS Y HERRAJES PARA TEMPLADO

HERRAJES CON TAPA
GT / MILLENNIUM / N / T

MILLENNIUM Acabados en: inox brillo - inox satinado.

330M

Punto de giro techillo para 3
Espesor vidrio 8-10 mm.

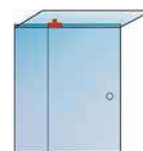
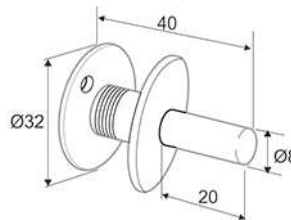

331M

Unión una luna sin anclaje
interior.
Espesor vidrio 8-10 mm.

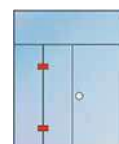
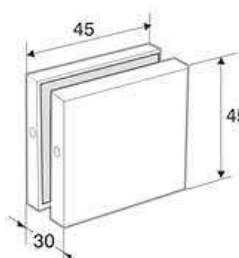

332M

Punto de giro montante
doble en batería de
puertas.
Espesor vidrio 8-10 mm.

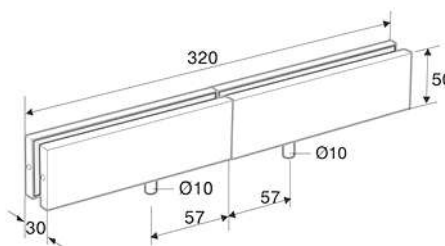

333M

Pernio bajo cuadradillo 16/19
giro desplazado.
Espesor vidrio 8-10 mm.

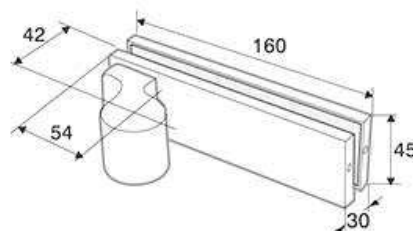

334M

Pernio alto giro desplazado.
Espesor vidrio 8-10 mm.

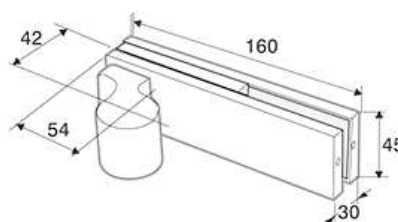

MILLENNIUM Acabados en: inox brillo - inox satinado

335M

Punto de giro montante desplazado.
Espesor vidrio 8-10 mm.

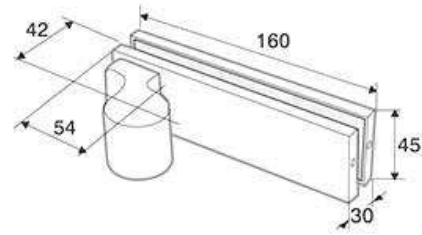

336M

Punto de giro lateral motante giro desplazado.
Espesor vidrio 8-10 mm.

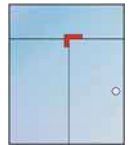
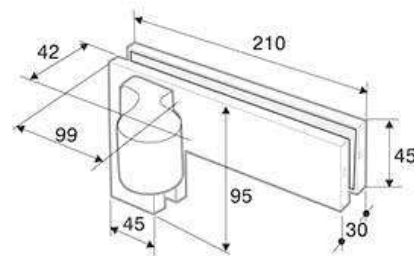

337M

Pernio bajo cuadradillo 16/19 giro desplazado desplazable.
Espesor vidrio 8-10 mm.

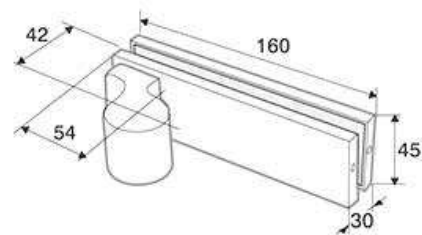

338M

Pernio alto giro desplazado desplazable.
Espesor vidrio 8-10 mm.

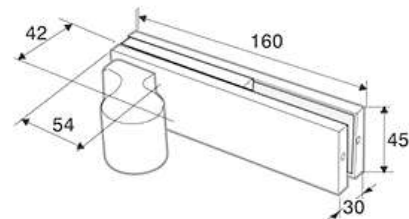

339M

Punto de giro montante giro desplazado desplazable.
Espesor vidrio 8-10 mm.

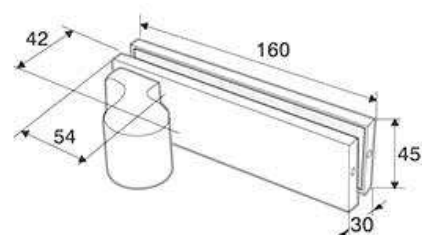

PERNIOS Y HERRAJES

ABATIBLES: Pernios y herrajes
GT / MILLENNIUM / N / T

MILLENNIUM

340M

Pernio alto regulable
desplazable.
Espesor vidrio 8-10 mm.

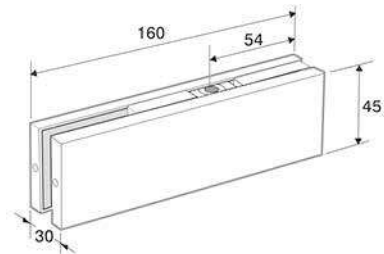

341M

Pernio bajo regulable
cuadracillo 16/19.
Espesor vidrio 8-10 mm.

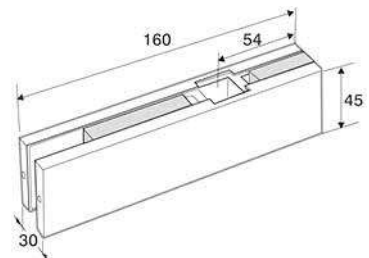

342M

Pernio bajo regulable
desplazable regleta.
Espesor vidrio 8-10 mm.

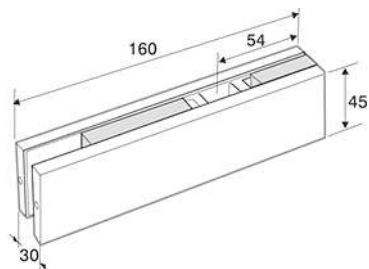

343M

Pernio alto no regulable.
Espesor vidrio 8-10 mm.

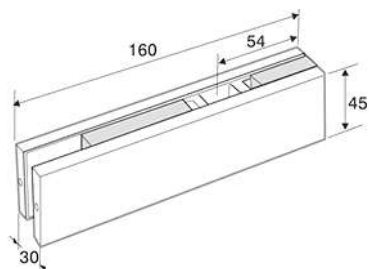

N Acabados en: inox brillo - inox satinado

DISPONIBLES PARA VIDRIO DE 12 MM

101N

Pernio alto.
Espesor vidrio 10 mm.

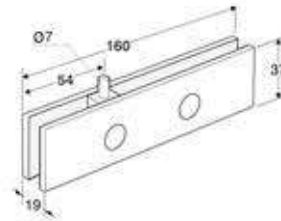

101NR

Pernio alto reforzado.
Espesor vidrio 10 mm.

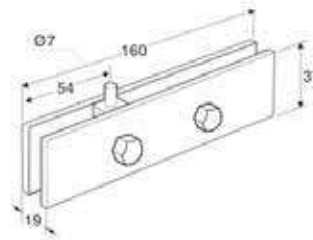

130N

Punto de giro montante pared.
Espesor vidrio 10 mm.

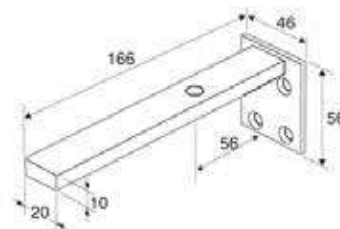

141N

Pernio alto para giro desplazado.
Espesor vidrio 10 mm.

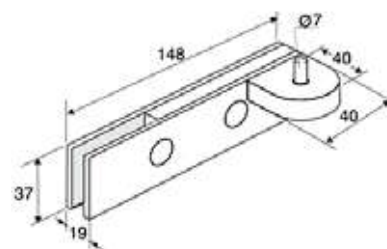

142N

Pernio bajo cuadradillo 16/9 para giro desplazado.
Espesor vidrio 10 mm.

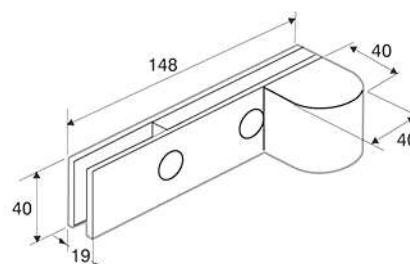

PERNIOS Y HERRAJES PARA TEMPLADO



INOX MACIZO

GT / MILLENNIUM / N / T

N Acabados en: inox brillo - inox satinado

DISPONIBLES PARA VIDRIO DE 12 MM

401N

Punto de giro lateral
montante.
Espesor vidrio 10 mm.

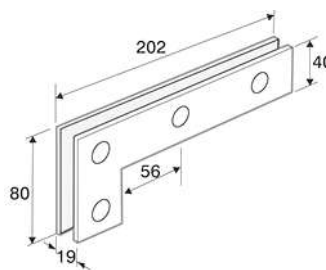

401N90

Punto de giro lateral
montante.
Espesor vidrio 10 mm.

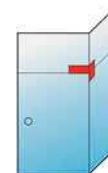
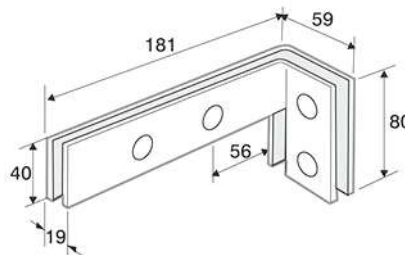

401NC

Punto de giro lateral
montante taladros ciegos.
Espesor vidrio 10 mm.

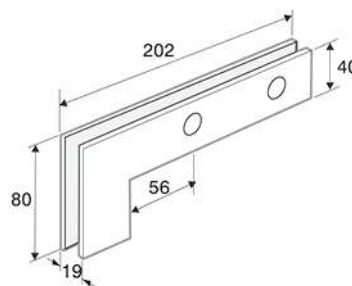

401NC90

Punto de giro lateral
montante taladros ciegos
ángulo 90°.
Espesor vidrio 10 mm.

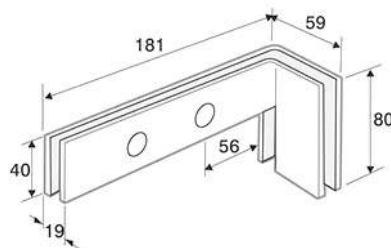

403

Punto de giro montante.
Espesor vidrio 10 mm.

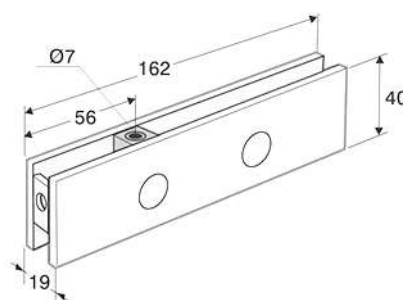

N Acabados en: inox brillo - inox satinado

DISPONIBLES PARA VIDRIO DE 12 MM

403N/2

Punto de giro montante desplazable.
Espesor vidrio 10 mm.

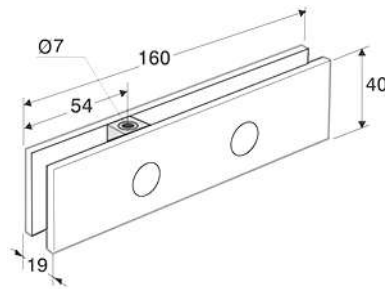

404N

Punto de giro montante en batería de puertas.
Espesor vidrio 10 mm.

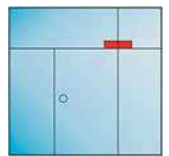
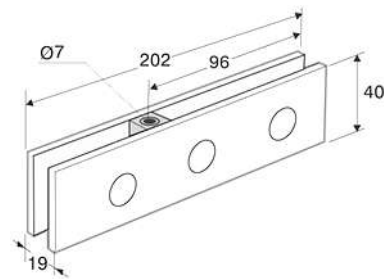

409N

Punto de giro montante alet.
Espesor vidrio 10 mm.

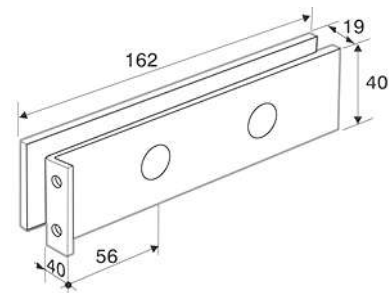

420N

Punto de giro montante doble en batería de puertas.
Espesor vidrio 10 mm.

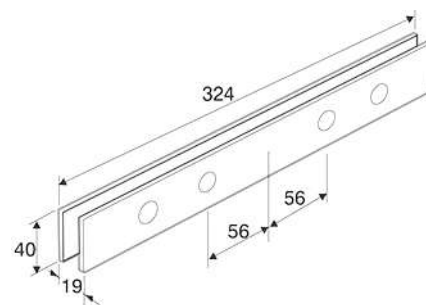

431N

Punto de giro lateral montante con contrafuerte.
Espesor vidrio 10 mm.

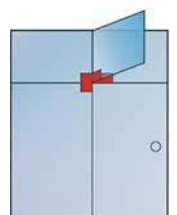
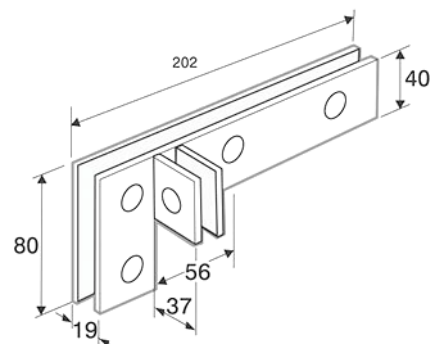

PERNIOS Y HERRAJES PARA TEMPLADO

INOX MACIZO
GT / MILLENNIUM / N / T

N Acabados en: inox brillo - inox satinado

DISPONIBLES PARA VIDRIO DE 12 MM

440N

Punto de giro superior
desplazado para 141N.
Espesor vidrio 10 mm.

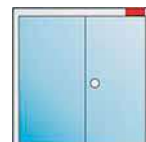
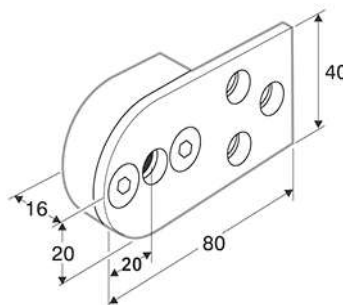

441N

Punto de giro lateral
montante giro desplazado
para 141N.
Espesor vidrio 10 mm.

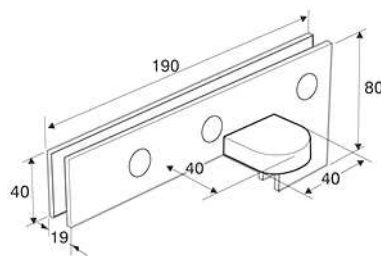

442N

Punto de giro montante
giro desplazado para
141N.
Espesor vidrio 10 mm.

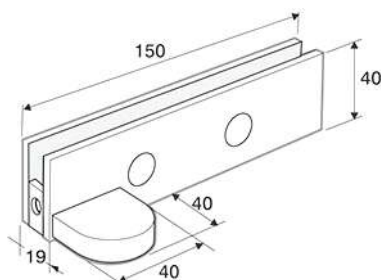

451N

Punto de giro superior
techillo.
Espesor vidrio 10 mm.

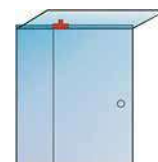
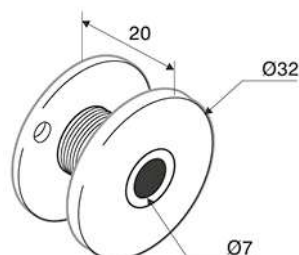

403N

Punto de giro superior
para 101N.
Espesor vidrio 10 mm.

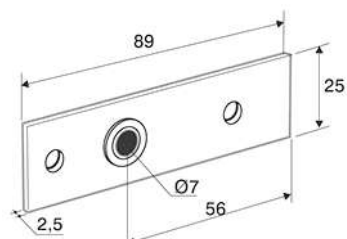

N Acabados en: inox brillo - inox satinado

DISPONIBLES PARA VIDRIO DE 12 MM

463CI

Tejuelo cuadradillo 13/16.
Espesor vidrio 10 mm.

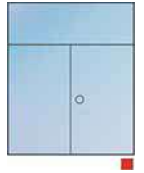
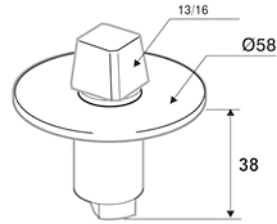

463C

Tejuelo cuadradillo 16/19.
Espesor vidrio 10 mm.

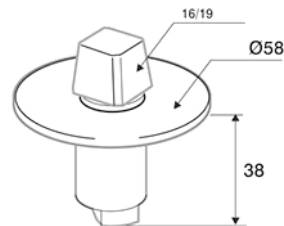

463E

Tejuelo europeo.
Espesor vidrio 10 mm.

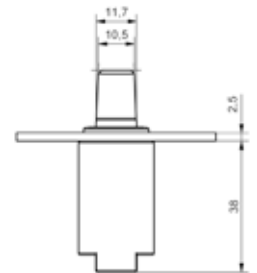
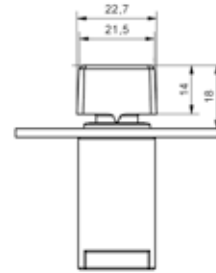
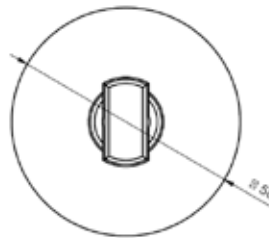

463N

Tejuelo regleta.
Espesor vidrio 10 mm.

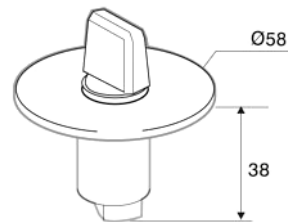

505N

Unión dos lunas vertical.
Espesor vidrio 10 mm.

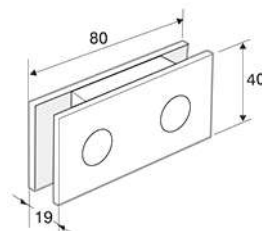

PERNIOS Y HERRAJES PARA TEMPLADO

INOX MACIZO
GT / MILLENNIUM / N / T

N Acabados en: inox brillo - inox satinado

DISPONIBLES PARA VIDRIO DE 12 MM

514N
Unión cuatro lunas.
Espesor vidrio 10 mm.

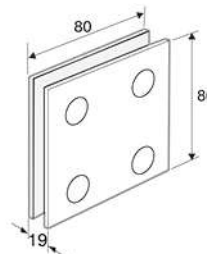

514N90
Unión cuatro lunas
ángulo 90°.
Espesor vidrio 10 mm.

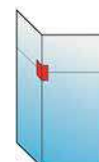
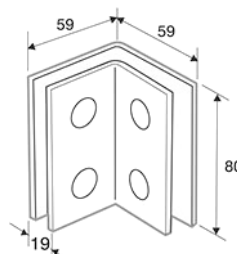

519N
Unión tres lunas tope.
Espesor vidrio 10 mm.

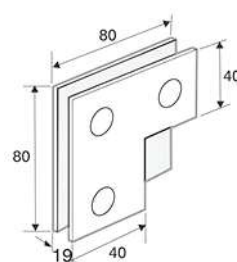

519N90
Unión tres lunas tope
ángulo 90°.
Espesor vidrio 10 mm.

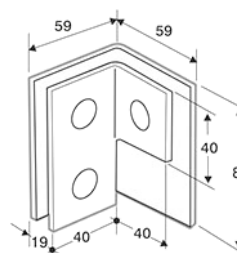

N Acabados en: inox brillo - inox satinado

DISPONIBLES PARA VIDRIO DE 12 MM

519NC

Unión tres lunas tope
taladros ciegos.
Espesor vidrio 10 mm.

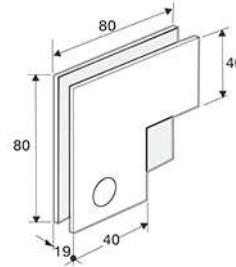

521N

Unión tres lunas.
Espesor vidrio 10 mm.

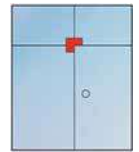
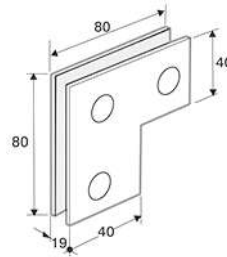

521N90

Unión tres lunas
ángulo 90°.
Espesor vidrio 10 mm.

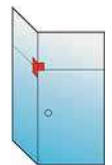
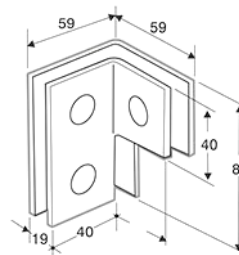

521NC

Unión tres lunas taladros
ciegos.
Espesor vidrio 10 mm.

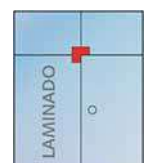
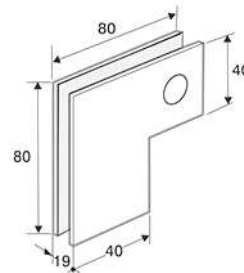

PERNIOS Y HERRAJES PARA TEMPLADO

INOX MACIZO
GT / MILLENNIUM / N / T

N Acabados en: inox brillo - inox satinado

DISPONIBLES PARA VIDRIO DE 12 MM

555N
Unión una luna.
Espesor vidrio 10 mm.

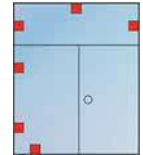
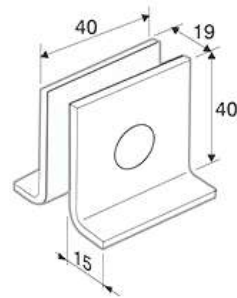

555NE
Unión una luna taladros
anclaje en aletas exteriores.
Espesor vidrio 10 mm.

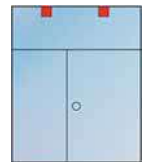
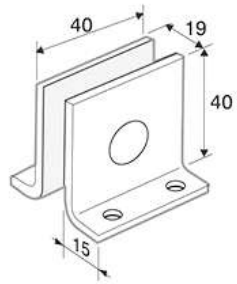

555S
Unión una luna suelo/techo.
Espesor vidrio 10 mm.

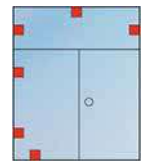
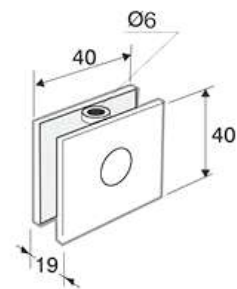

555V
Unión una luna vértices.
Espesor vidrio 10 mm.

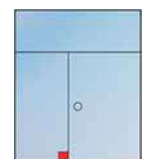
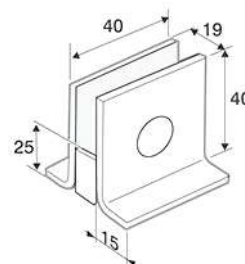

N Acabados en: inox brillo - inox satinado

DISPONIBLES PARA VIDRIO DE 12 MM

571N

Unión dos lunas.
Espesor vidrio 10 mm.

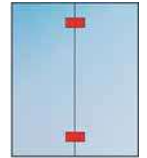
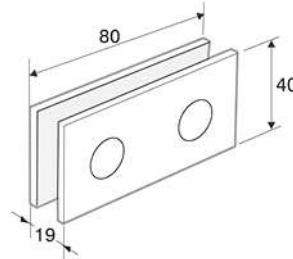

573N

Contrafuerte.
Espesor vidrio 10 mm.

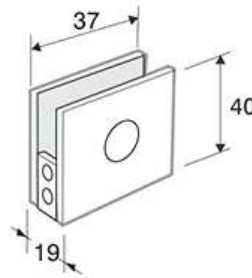

1032

Pernio bajo regleta
doble.
Espesor vidrio 10 mm.

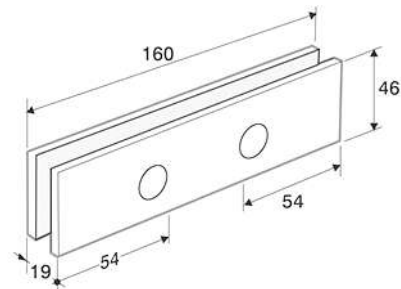

1032R

Pernio bajo regleta
reforzado.
Espesor vidrio 10 mm.

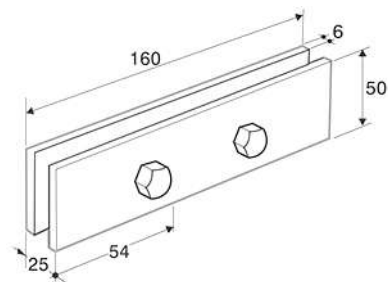

PERNIOS Y HERRAJES PARA TEMPLADO

HERRAJES Y COMPLEMENTOS
GT / MILLENNIUM / N / T

T Acabados en: inox brillo - inox satinado

DISPONIBLES PARA VIDRIO DE 12 MM

S1LAA

Unión una luna sin anclaje interior.

Espesor vidrio 10 mm.

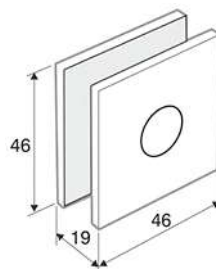

S1LAAS

Unión una luna suelo/techo.

Espesor vidrio 10 mm.

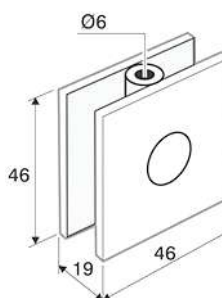

S1LAAT

Unión una luna tope.

Espesor vidrio 10 mm.

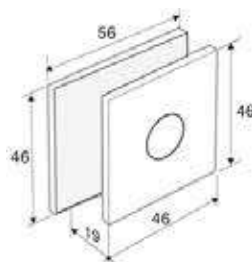

S1LAC

Unión una luna.

Espesor vidrio 10 mm.



S1LAD

Unión una luna vértices.

Espesor vidrio 10 mm.

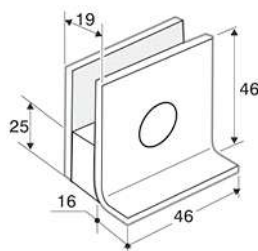

T Acabados en: inox brillo - inox satinado

DISPONIBLES PARA VIDRIO DE 12 MM

S1LADT

Unión una luna vértices
tope en D.
Espesor vidrio 10 mm.

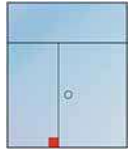
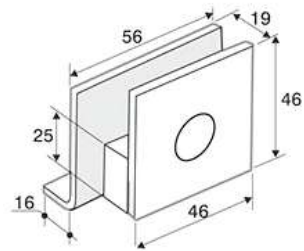

S1LBBE

Unión una luna taladros
anclaje en aletas
exteriores.
Espesor vidrio 10 mm.

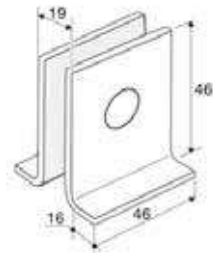

S1LBC

Unión una luna.
Espesor vidrio 10 mm.

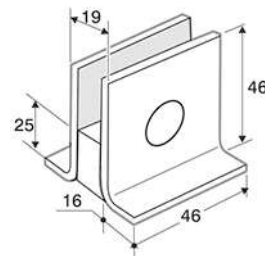

S1LBD

Unión una luna vértices.
Espesor vidrio 10 mm.

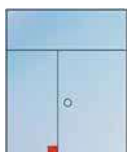
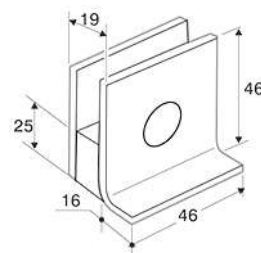

S1LDAT

Unión una luna vértices tope
en D.
Espesor vidrio 10 mm.

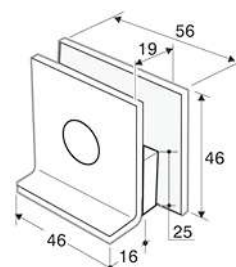

PERNIOS Y HERRAJES PARA TEMPLADO

HERRAJES Y COMPLEMENTOS
GT / MILLENNIUM / N / T

T Acabados en: inox brillo - inox satinado

DISPONIBLES PARA VIDRIO DE 12 MM

S1LEE

Unión una luna taladros
anclaje en aletas exteriores.
Espesor vidrio 10 mm.

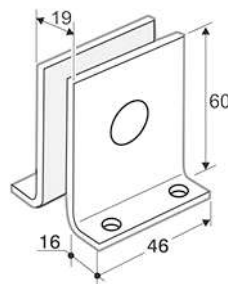

A1A2

Unión ángulo 90°.
Espesor vidrio 10 mm.



A1A2S

Unión ángulo 90° suelo/
techo.
Espesor vidrio 10 mm.



ALP

Apoyo lateral puerta.
Espesor vidrio 10 mm.



GBCP

Guía baja puerta
corredera.
Espesor vidrio 10 mm.



T Acabados en: inox brillo - inox satinado

DISPONIBLES PARA VIDRIO DE 12 MM

CGPV/TPV

Punto de giro/tejuelo
vitrina.
Espesor vidrio 10 mm.



CPM

Cerradero presión.
Espesor vidrio 10 mm.



CPMF

Cerrojillo+cerradero presión.
Espesor vidrio 10 mm.



PM

Cerrojillo presión.
Espesor vidrio 10 mm.



PMF

Cerrojillo presión.
Espesor vidrio 10 mm.



PV6

Pernio vitrina vidrio 6 mm.
Espesor vidrio 10 mm.



PV8

Pernio vitrina vidrio 8 mm.
Espesor vidrio 10 mm.



PV10

Pernio vitrina vidrio 10 mm.
Espesor vidrio 10 mm.



S1LT

Unión luna techillo.
Espesor vidrio 10 mm.



SLT

Unión dos lunas techillo.
Espesor vidrio 10 mm.



PERNIOS Y HERRAJES PARA TEMPLADO

HERRAJES Y COMPLEMENTOS
GT / MILLENNIUM / N / T



T Acabados en: inox brillo - inox satinado

DISPONIBLES PARA VIDRIO DE 12 MM

SR

Soporte rótulos.
Espesor vidrio 10 mm.



TP1

Tope presión simple.
Espesor vidrio 10 mm.



TP2

Tope presión doble.
Espesor vidrio 10 mm.



TP3

Tope carpintería.
Espesor vidrio 10 mm.



SL90°T

Sujeción luna 90° techillo.
Espesor vidrio 10 mm.



MEIA Acabados en: inox brillo - inox satinado

1000
 Picaporte/palanca
 cilindro.
 Espesor vidrio 10 mm.

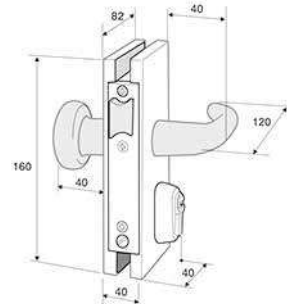

1001
 Picaporte/palanca
 cilindro manillas.
 Espesor vidrio 10 mm.

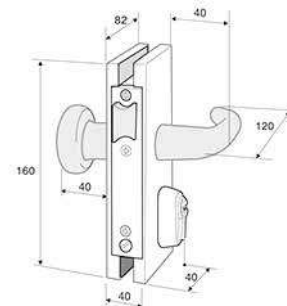

1002
 Picaporte/palanca cilindro y
 pomos.
 Espesor vidrio 10 mm.

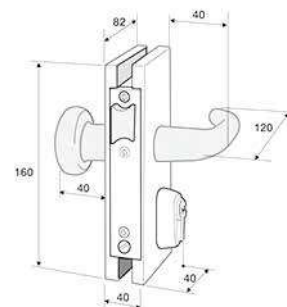

1003
 Picaporte/palanca cilindro y
 manilla interior.
 Espesor vidrio 10 mm.

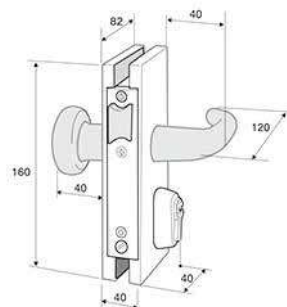

1004
 Picaporte/palanca cilindro y
 pomo interior.
 Espesor vidrio 10 mm.

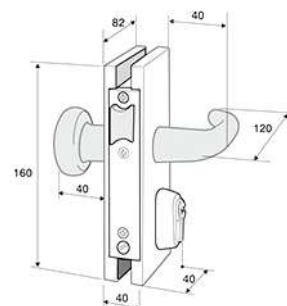

CERRADURAS Y CERRADEROS

ABATIBLES: Cerradura clásica

MEIA / ARES-TER / SCONTO / INTERNO / INDIETRO / JANO / TERRA

MEIA Acabados en: inox brillo - inox satinado

1005

Picaporte/palanca cilindro
manilla interior y pomo fijo
exterior.

Espesor vidrio 10 mm.

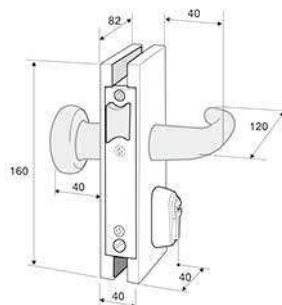

1006

Picaporte/palanca cilindro
pomo interior y pomo fijo
exterior.

Espesor vidrio 10 mm.

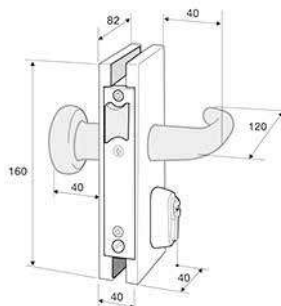

1007

Palanca cilindro.

Espesor vidrio 10 mm.

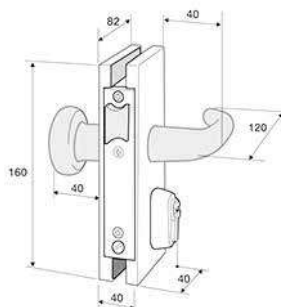

1008

Palanca cilindro y pomos
fijos.

Espesor vidrio 10 mm.

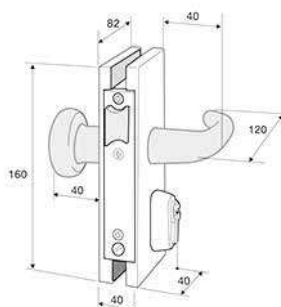

1009

Picaporte manillas.

Espesor vidrio 10 mm.

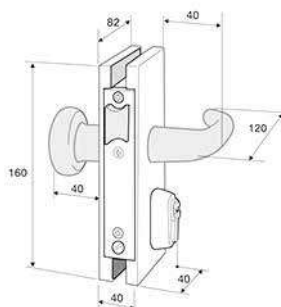

MEIA Acabados en: inox brillo - inox satinado

1010
Picaporte pomos.
Espesor vidrio 10 mm.

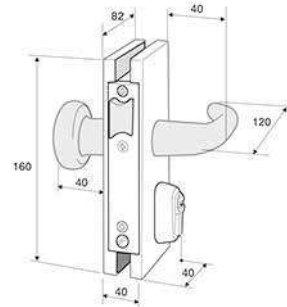

1011
Picaporte 1/2 cilindro exterior y manilla interior.
Espesor vidrio 10 mm.

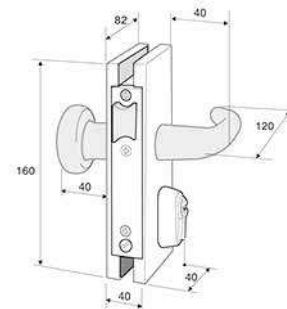

1012
Picaporte 1/2 cilindro exterior y pomo interior.
Espesor vidrio 10 mm.

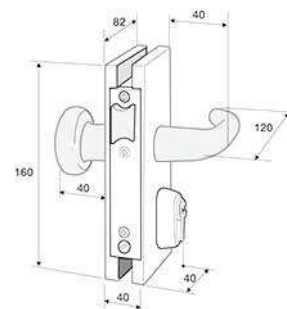

1017
Picaporte 1/2 cilindro y pomo fijo exterior con manilla interior.
Espesor vidrio 10 mm.

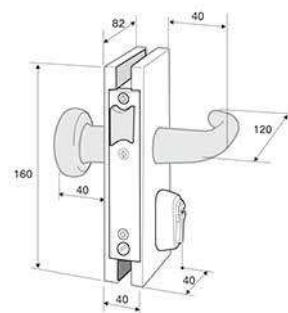

1018
Picaporte 1/2 cilindro y pomo fijo exterior con pomo interior.
Espesor vidrio 10 mm.

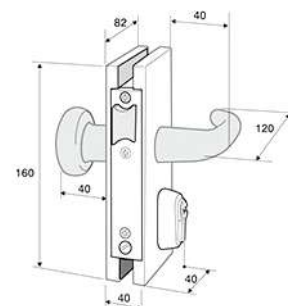

CERRADURAS Y CERRADEROS

ABATIBLES: Cerradura clásica

MEIA / ARES-TER / SCONTO / INTERNO / INDIETRO / JANO / TERRA

MEIA Acabados en: inox brillo - inox satinado

1019

Picaporte cilindro.
Espesor vidrio 10 mm.

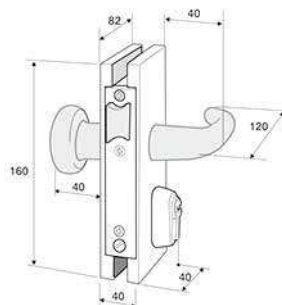

1020

Picaporte cilindro y pomos
fijos.
Espesor vidrio 10 mm.

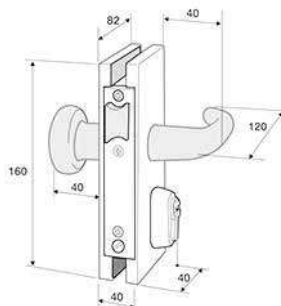

1021

Picaporte/palanca condensa y
manillas.
Espesor vidrio 10 mm.

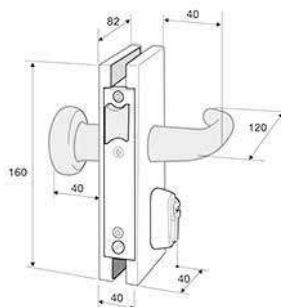

1022

Picaporte/palanca condensa y
pomos.
Espesor vidrio 10 mm.

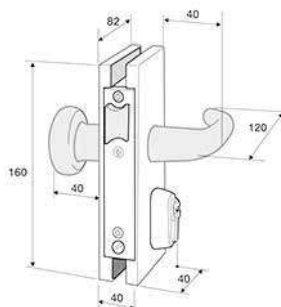

1039

Palanca condensa.
Espesor vidrio 10 mm.

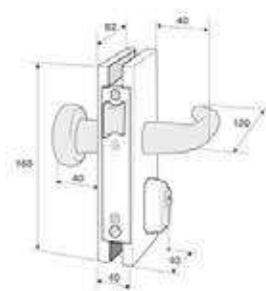

MEIA ON/OFF Acabados en: inox brillo - inox satinado

1039/1
Palanca condena
pomos fijos.
Espesor vidrio 10 mm.

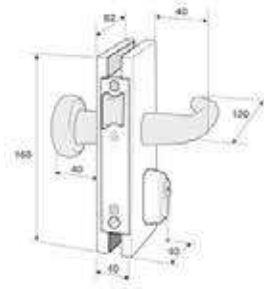

1038
Picaporte/palanca condena
manillas.
Espesor vidrio 10 mm.

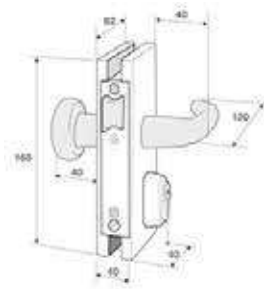

1038/1
Picaporte/palanca condena
pomos oval.
Espesor vidrio 10 mm.

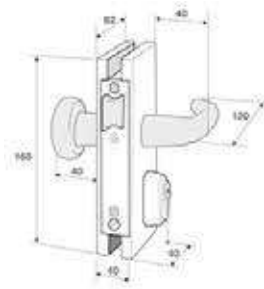

ABATIBLES: Cerraderos

MEIA / ARES-TER / SCONTO / INTERNO / INDIETRO / JANO / TERRA

MEIA Acabados en: inox brillo - inox satinado

2001

Picaporte/palanca.
Espesor vidrio 10 mm.

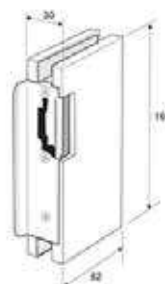

2002

Picaporte/palanca tope.
Espesor vidrio 10 mm.

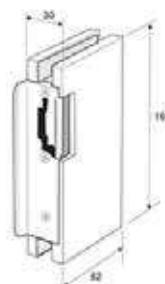

2003

Picaporte/palanca eléctrico
12V AC/DC con desbloqueo.
Espesor vidrio 10 mm.

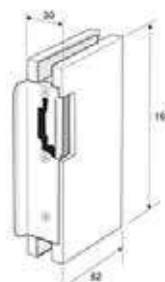

2004

Picaporte/palanca eléctrico
tope 12V AC/DC con
desbloqueo.
Espesor vidrio 10 mm.



2005

Palanca.
Espesor vidrio 10 mm.

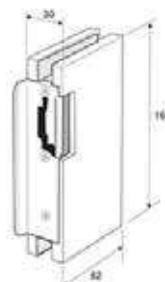

MEIA Acabados en: inox brillo - inox satinado

2006
Palanca tope.
Espesor vidrio 10 mm.

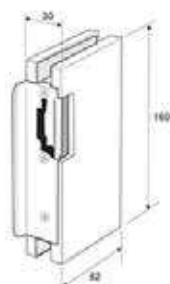

2007
Picaporte.
Espesor vidrio 10 mm.

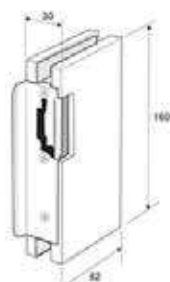

2008
Picaporte tope.
Espesor vidrio 10 mm.

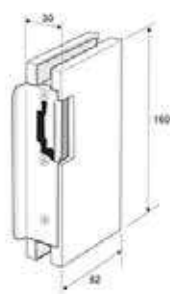

2009
Picaporte eléctrico 12V AC/DC
con desbloqueo.
Espesor vidrio 10 mm.



2010
Picaporte eléctrico tope 12V
AC/DC con desbloqueo.
Espesor vidrio 10 mm.

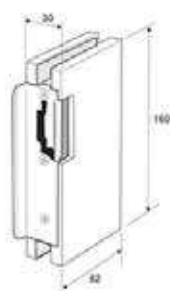

ABATIBLES: Cerradura petaca con muesca

MEIA / ARES-TER / SCONTO / INTERNO / INDIETRO / JANO / TERRA

ARES Acabados en: inox brillo - inox satinado

1200

Picaporte/palanca cilindro.
Espesor vidrio 10 mm.

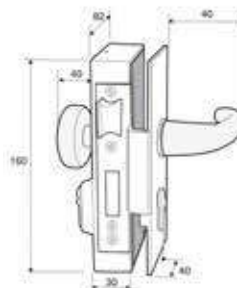

1201

Picaporte/palanca cilindro y
manillas.
Espesor vidrio 10 mm.

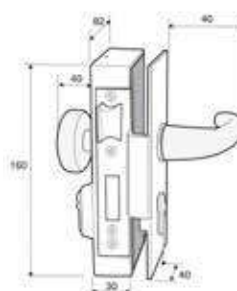

1202

Picaporte/palanca cilindro y
pomos.
Espesor vidrio 10 mm.

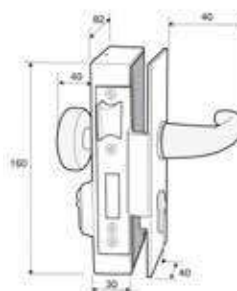

1203

Picaporte/palanca cilindro y
manilla en mecanismo.
Espesor vidrio 10 mm.

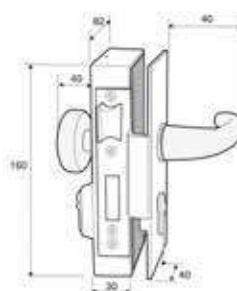

1204

Picaporte/palanca cilindro
y pomo en mecanismo.
Espesor vidrio 10 mm.

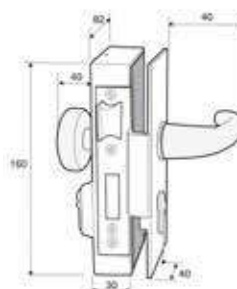

ARES Acabados en: inox brillo - inox satinado

1205
Picaporte/palanca
cilindro con manilla en
mecanismo y pomo
fijo en la escuadra.
Espesor vidrio 10 mm.

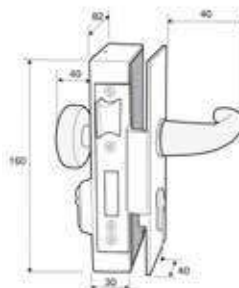

1206
Picaporte/palanca
cilindro con pomo en
mecanismo y pomo fijo
en escuadra.
Espesor vidrio 10 mm.

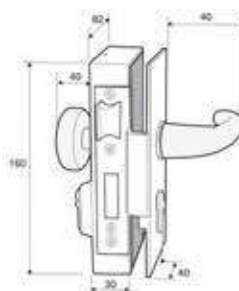

1207
Palanca cilindro.
Espesor vidrio 10 mm.

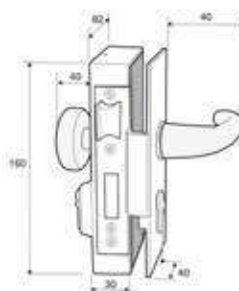

1208
Palanca cilindro y pomos fijos.
Espesor vidrio 10 mm.

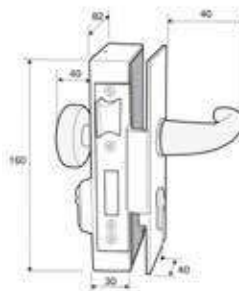

1209
Picaporte manillas.
Espesor vidrio 10 mm.

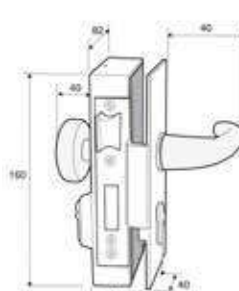

CERRADURAS Y CERRADEROS

ABATIBLES: Cerradura petaca con muesca

MEIA / ARES-TER / SCONTO / INTERNO / INDIETRO / JANO / TERRA

ARES Acabados en: inox brillo - inox satinado

1210

Picaporte pomos.
Espesor vidrio 10 mm.

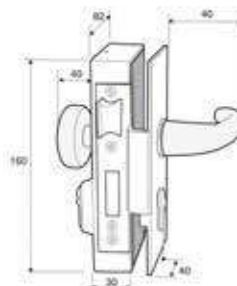

1211

Gancho cilindro.
Espesor vidrio 10 mm.

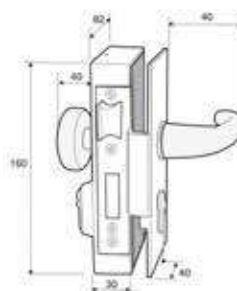

1212

Palanca vaivén cilindro.
Espesor vidrio 10 mm.

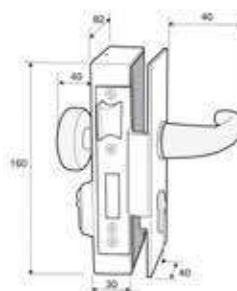

1219

Picaporte cilindro.
Espesor vidrio 10 mm.

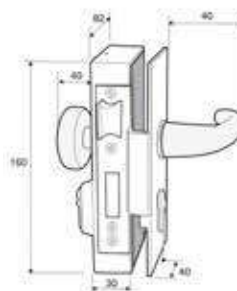

1220

Picaporte cilindro y pomos
fijos.
Espesor vidrio 10 mm.

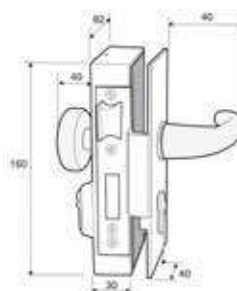

ARES MODULAR Acabados en: inox brillo - inox satinado

M3000

Picaporte/palanca cilindro manillas.

Espesor vidrio 10 mm.

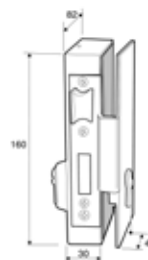

M3003

Picaporte/palanca cilindro 1/2 manilla en mecanismo.

Espesor vidrio 10 mm.

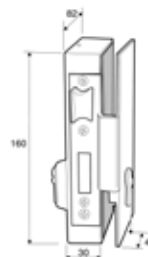

M3006

Picaporte manillas.

Espesor vidrio 10 mm.

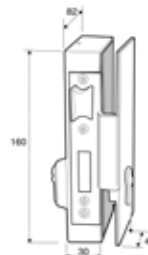

M3009

Picaporte 1/2 cilindro en mecanismo 1/2 manilla en la escuadra.

Espesor vidrio 10 mm.

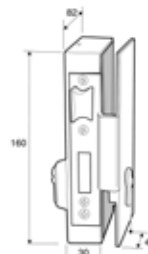

M3011

Picaporte condena en mecanismo y manillas.

Espesor vidrio 10 mm.

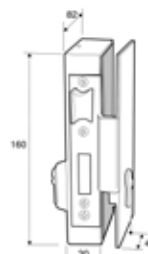

M3013

Picaporte/palanca cilindro 1/2 manilla en la escuadra.

Espesor vidrio 10 mm.

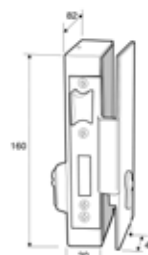

ABATIBLES: Cerradura petaca sin muesca

MEIA / ARES-TER / SCONTO / INTERNO / INDIETRO / JANO / TERRA

TER Acabados en: inox brillo - inox satinado

1023
Picaporte/palanca
condena y manilla en
mecanismo.
Espesor vidrio 10 mm.

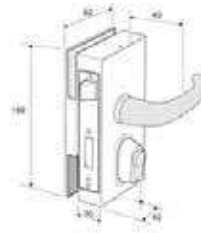

1024
Picaporte/palanca
condena y pomo en
mecanismo.
Espesor vidrio 10 mm.



1027
Picaporte/palanca 1/2 cilindro
en mecanismo.
Espesor vidrio 10 mm.



1028
Picaporte/palanca 1/2 cilindro
y manilla en mecanismo.
Espesor vidrio 10 mm.



1029
Picaporte/palanca 1/2 cilindro
y pomo en mecanismo.
Espesor vidrio 10 mm.



1031
Picaporte/palanca 1/2 cilindro
y pomo fijo en mecanismo.
Espesor vidrio 10 mm.

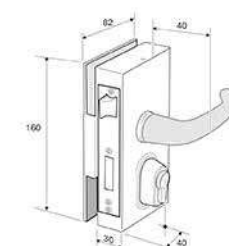

TER Acabados en: inox brillo - inox satinado

1033
Picaporte manilla en
mecanismo.
Espesor vidrio 10 mm.



1034
Picaporte pomo en
mecanismo.
Espesor vidrio 10 mm.



1035
Palanca 1/2 cilindro en
mecanismo.
Espesor vidrio 10 mm.



1036
Picaporte 1/2 cilindro en
mecanismo.
Espesor vidrio 10 mm.



1045
Gancho no escamoteable
cilindro.
Espesor vidrio 10 mm.

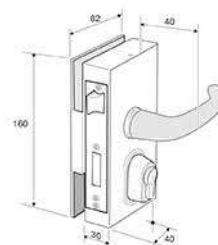

1320
Palanca vaivén 1/2 cilindro.
Espesor vidrio 10 mm.

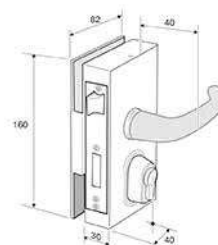

CERRADURAS Y CERRADEROS

ABATIBLES: Cerradura petaca con muesca MODULAR

MEIA / ARES-TER / SCONTO / INTERNO / INDIETRO / JANO / TERRA

TER MODULAR

Acabados en: inox brillo - inox satinado

M4001

Picaporte/palanca 1/2 cilindro

1/2 manilla en mecanismo .

Espesor vidrio 10 mm.

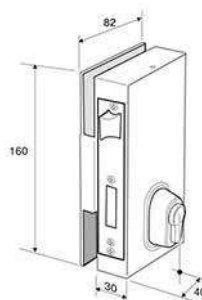

M4007

Picaporte 1/2 manilla en

mecanismo.

Espesor vidrio 10 mm.

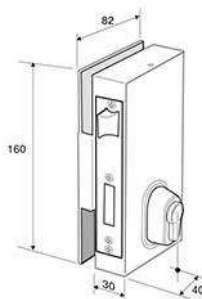

M3006

Picaporte manillas.

Espesor vidrio 10 mm.

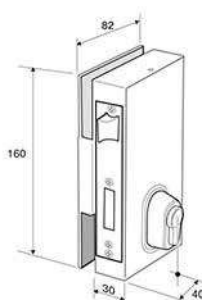

ARES Y TER Acabados en: inox brillo - inox satinado

2011
Picaporte/palanca
12V AC con
desbloqueo.
Espesor vidrio 10 mm.

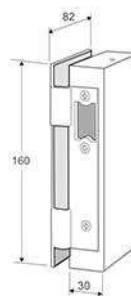

2012
Picaporte/palanca
eléctrico tope
12V AC
con desbloqueo y tope
en escuadra.
Espesor vidrio 10 mm.

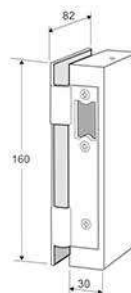

2013
Palanca.
Espesor vidrio 10 mm.

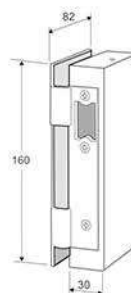

2014
Palanca tope en la
escuadra.
Espesor vidrio 10 mm.

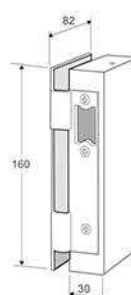

2015
Picaporte eléctrico 12V AC
con desbloqueo.
Espesor vidrio 10 mm.

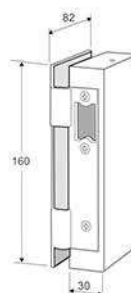

ABATIBLES: Cerraderos petaca

MEIA / ARES-TER / SCONTO / INTERNO / INDIETRO / JANO / TERRA

ARES Y TER Acabados en: inox brillo - inox satinado

2016

Picaporte eléctrico 12V AC
con desbloqueo y tope en la
escuadra.
Espesor vidrio 10 mm.

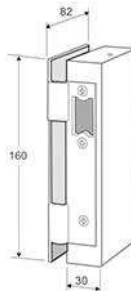

2021

Picaporte.
Espesor vidrio 10 mm.

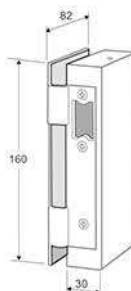

2022

Picaporte/palanca
Palanca/vaivén.
Espesor vidrio 10 mm.

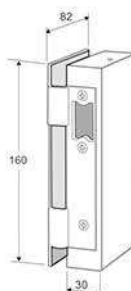

2023

Picaporte con tope en la
escuadra.
Espesor vidrio 10 mm.

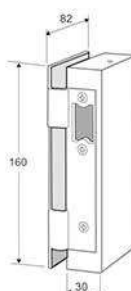

2024

Picaporte/palanca con
tope en la escuadra.
Espesor vidrio 10 mm.

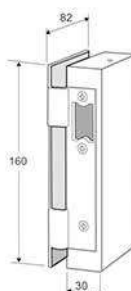

ARES Y TER Acabados en: inox brillo - inox satinado

2027
Palanca con tope en el mecanismo.
Espesor vidrio 10 mm.

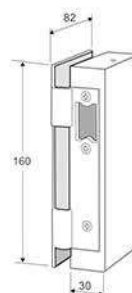

2028
Picaporte con tope en el mecanismo.
Espesor vidrio 10 mm.

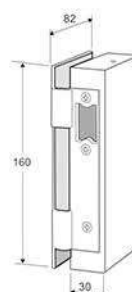

2029
Picaporte/palanca con tope en el mecanismo.
Espesor vidrio 10 mm.

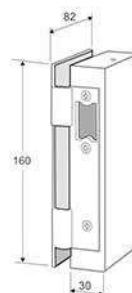

2033
Gancho.
Espesor vidrio 10 mm.

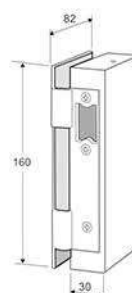

ABATIBLES: Cerradura galce

MEIA / ARES-TER / **SCONTO** / INTERNO / INDIETRO / JANO / TERRA

SCONTO Acabados en: inox brillo - inox satinado

1400
Picaporte/palanca cilindro.
Espesor vidrio 10 mm.

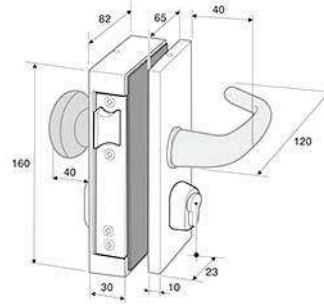

1400-1
Picaporte/palanca cilindro y
manillas.
Espesor vidrio 10 mm.

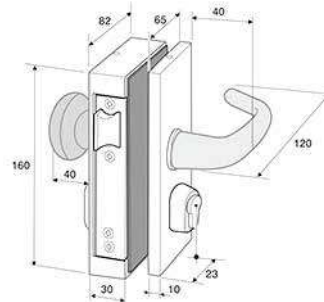

1400-2
Picaporte/palanca cilindro y
pomos.
Espesor vidrio 10 mm.

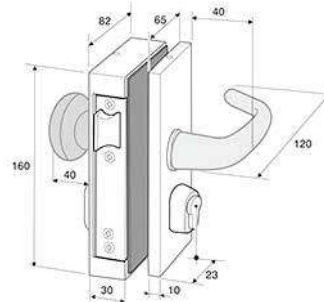

1401-1
Picaporte/palanca cilindro
y manilla en tapa.
Espesor vidrio 10 mm.

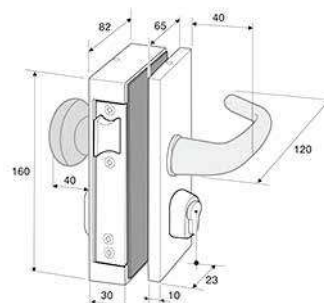

1401-2
Picaporte/palanca
cilindro y pomo en
tapa.
Espesor vidrio 10 mm.

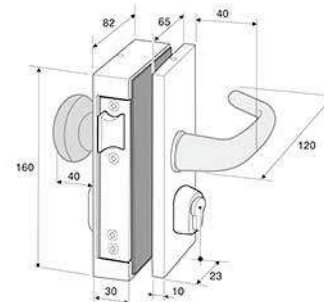

SCONTO Acabados en: inox brillo - inox satinado

1402-1

Picaporte/palanca cilindro
manilla en tapa y pomo fijo
en mecanismo.
Espesor vidrio 10 mm.

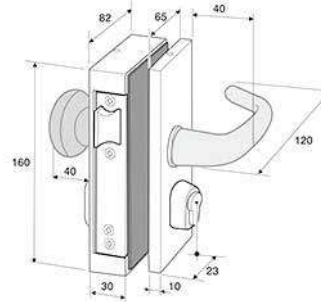

1403-1

Picaporte/palanca cilindro
pomo en tapa y pomo fijo en
mecanismo.
Espesor vidrio 10 mm.

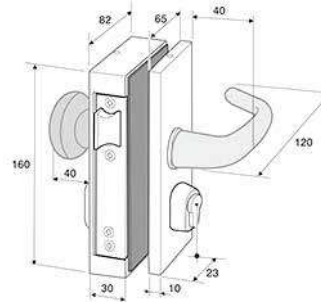

1410

Palanca cilindro.
Espesor vidrio 10 mm.

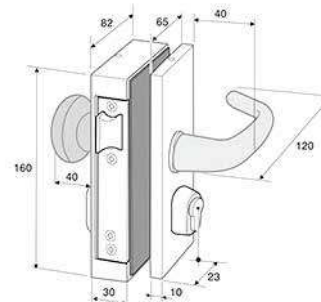

1410-1

Palanca cilindro y pomos
fijos.
Espesor vidrio 10 mm.

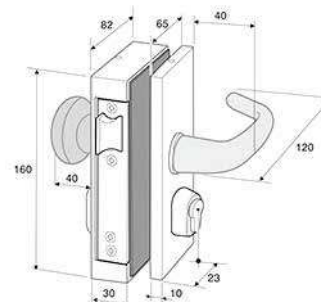

1415

Picaporte cilindro.
Espesor vidrio 10 mm.

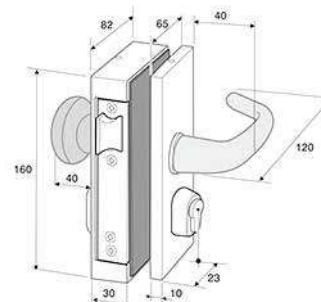

CERRADURAS Y CERRADEROS

ABATIBLES: Cerradura galce

MEIA / ARES-TER / **SCONTO** / INTERNO / INDIETRO / JANO / TERRA

SCONTO Acabados en: inox brillo - inox satinado

1415-1

Picaporte manillas.
Espesor vidrio 10 mm.

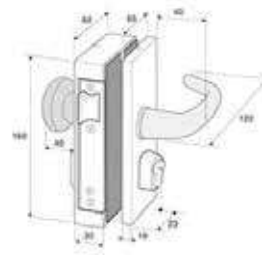

1415-2

Picaporte pomos.
Espesor vidrio 10 mm.

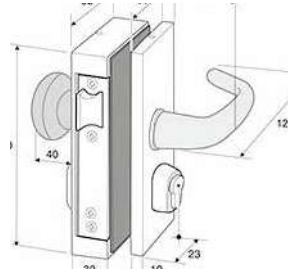

1416-1

Picaporte 1/2 cilindro en
mecanismo y manilla en
tapa.
Espesor vidrio 10 mm.

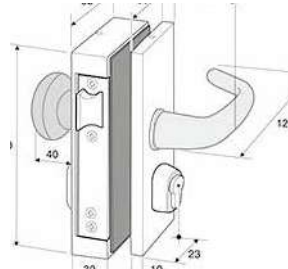

1416-2

Picaporte 1/2 cilindro en
mecanismo y pomo en tapa.
Espesor vidrio 10 mm.

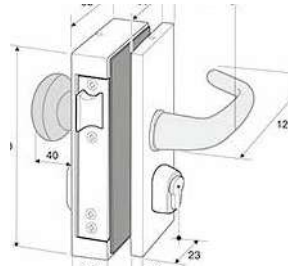

1417-1

Picaporte 1/2 cilindro pomo
en mecanismo y manilla en
tapa.
Espesor vidrio 10 mm.

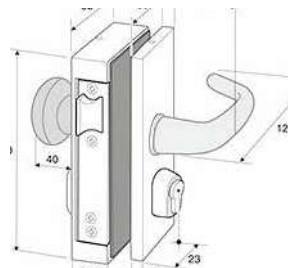

1417-2

Picaporte 1/2 cilindro manilla
en mecanismo y manilla en
tapa.
Espesor vidrio 10 mm.

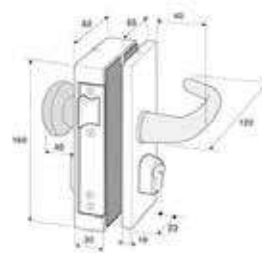

SCONTO Acabados en: inox brillo - inox satinado

1418-1

Picaporte 1/2 cilindro pomo fijo en mecanismo y pomo en tapa.
Espesor vidrio 10 mm.

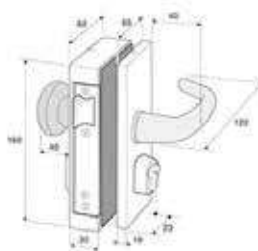

1419-1

Picaporte cilindro y pomos fijos.
Espesor vidrio 10 mm.

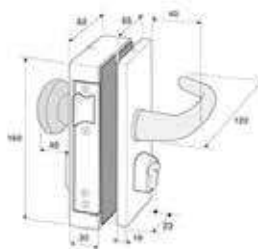

1425-1

Picaporte/palanca condena en tapa y manillas.
Espesor vidrio 10 mm.



1425-2

Picaporte/palanca condena en tapa y pomos.
Espesor vidrio 10 mm.

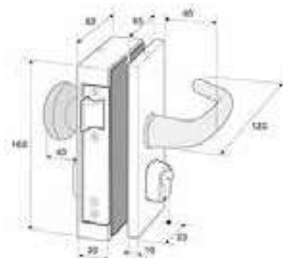

1426

Vaivén, cilindro.
Espesor vidrio 10 mm.

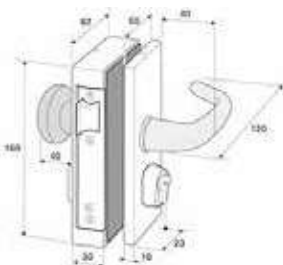

1427

Gancho, cilindro.
Espesor vidrio 10 mm.



CERRADURAS Y CERRADEROS

ABATIBLES: Cerradura galce

MEIA / ARES-TER / **SCONTO** / INTERNO / INDIETRO / JANO / TERRA

SCONTO MODULAR

Acabados en: inox brillo - inox satinado

M2000

Picaporte/palanca cilindro manillas.

Espesor vidrio 10 mm.

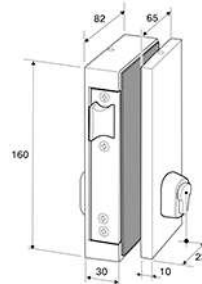

M2003

Picaporte/palanca cilindro 1/2 manilla en mecanismo.

Espesor vidrio 10 mm.

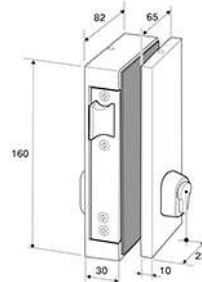

M2006

Picaporte manillas.

Espesor vidrio 10 mm.



M2007

Picaporte 1/2 manilla en tapa.

Espesor vidrio 10 mm.

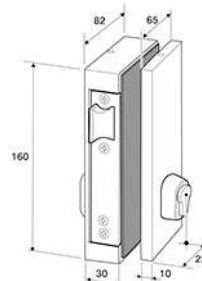

M2009

Picaporte 1/2 cilindro en mecanismo 1/2 manilla en tapa.

Espesor vidrio 10 mm.

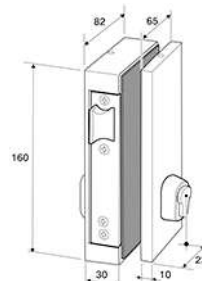

M2011

Picaporte condensa en tapa y manillas.

Espesor vidrio 10 mm.

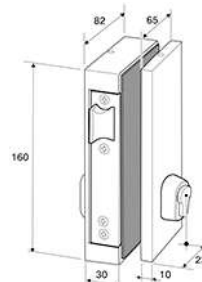

SCONTO MUESCA

Acabados en: inox brillo - inox satinado

2411
Instalaciones a 90°
con muesca.
Espesor vidrio 10 mm.



2412
Instalaciones a 90°
con muesca.
Espesor vidrio 10 mm.



2413
Instalaciones a 90°
con muesca.
Espesor vidrio 10 mm.

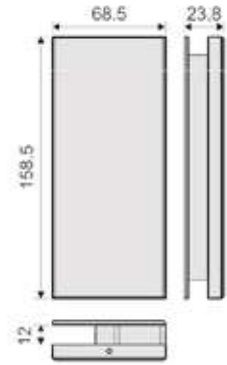

SCONTO PRESIÓN

2408
Instalaciones a 90°
con presión.
Espesor vidrio 10 mm.



2409
Instalaciones a 90°
con presión.
Espesor vidrio 10 mm.



241
Instalaciones a 90°
con presión.
Espesor vidrio 10 mm.

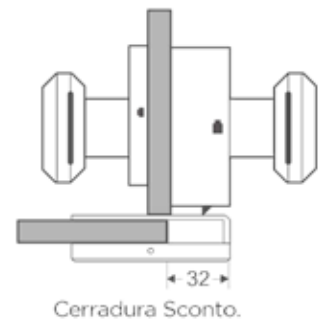
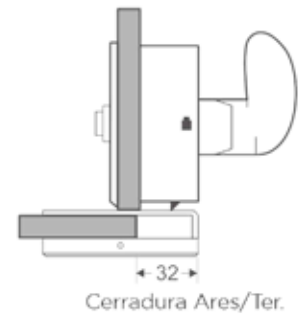

ABATIBLES: Cerraduras para interior

MEIA / ARES-TER / SCONTO / INTERNO / INDIETRO / JANO / TERRA

DESCRIPCIÓN Acabados en: inox brillo - inox satinado

1600

Picaporte manilla condena.
Espesor vidrio 8-10 mm.

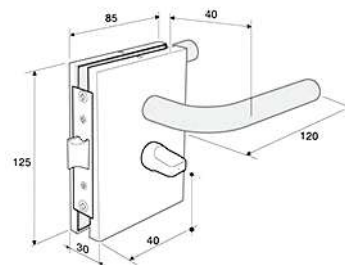

1600-1

Picaporte manilla condena.
Espesor vidrio 8-10 mm.

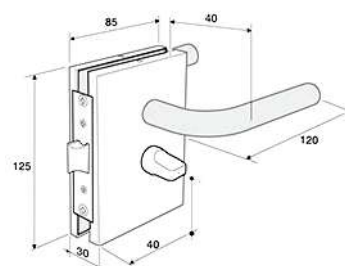

1601

Picaporte manilla.
Espesor vidrio 8-10 mm.

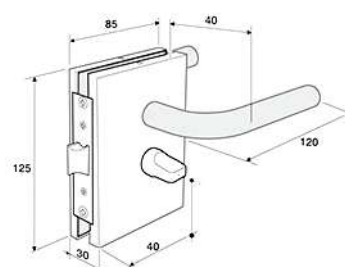

1601-1

Picaporte manilla.
Espesor vidrio 8-10 mm.

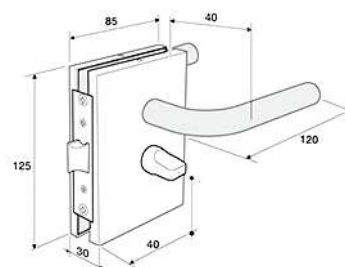

INTERNO MODULAR

Acabados en: inox brillo - inox satinado

M6000

Picaporte manillas.
Espesor vidrio 10 mm.



M6001

Picaporte condensa manillas.
Espesor vidrio 10 mm.

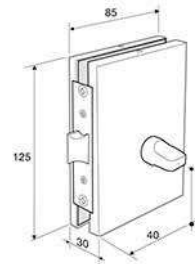

CERRADURAS Y CERRADEROS

INTERNO

Acabados en: inox brillo - inox satinado

2030

Picaporte vidrio.
Espesor vidrio 10 mm.



2031

Picaporte tope vidrio.
Espesor vidrio 10 mm.



3013

Picaporte carpintería.
Espesor vidrio 10 mm.



3014

Picaporte tope carpintería.
Espesor vidrio 10 mm.



CERRADURAS Y CERRADEROS

ABATIBLES: Cerraduras puerta vaivén

MEIA / ARES-TER / SCONTO / INTERNO / **INDIETRO** / JANO / TERRA

INDIETRO Acabados en: inox brillo - inox satinado

1500
Vaivén cilindro.
Espesor vidrio 10 mm.



1500-2
Vaivén cilindro pomos
fijos.
Espesor vidrio 10 mm.

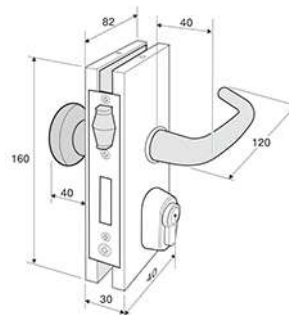

CERRADURAS Y CERRADEROS

ABATIBLES: Cerraderos puerta vaivén

MEIA / ARES-TER / SCONTO / INTERNO / **INDIETRO** / JANO / TERRA

INDIETRO Acabados en: inox brillo - inox satinado

2001
Vaivén palanca.



3012
Vaivén carpintería.



JANO Acabados en: inox brillo - inox satinado

1700
Picaporte cilindro con galce.
Espesor vidrio 10 mm.

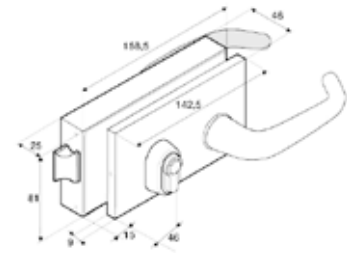

1701
Picaporte cilindro y manillas con galce.
Espesor vidrio 10 mm.

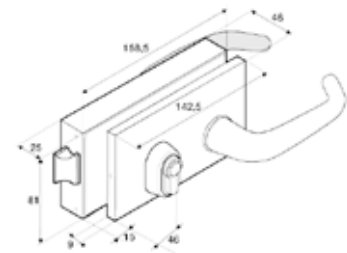

1702
Picaporte cilindro y pomos con galce.
Espesor vidrio 10 mm.

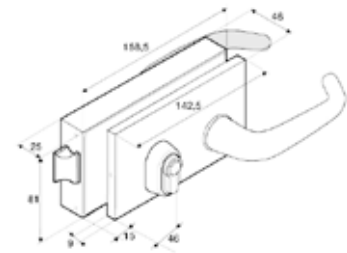

1703
Picaporte manillas con galce.
Espesor vidrio 10 mm.

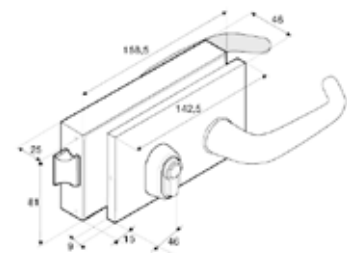

1704
Picaporte pomos con galce.
Espesor vidrio 10 mm.

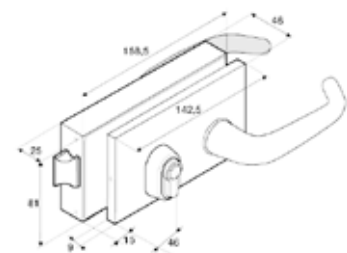

CERRADURAS Y CERRADEROS

ABATIBLES: Cerradura galce

MEIA / ARES-TER / SCONTO / INTERNO / INDIETRO / **JANO** / TERRA

JANO

Acabados en: inox brillo - inox satinado

1705

Cerradura para marco sin galce.

Espesor vidrio 10 mm.

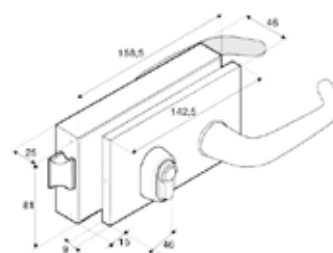

1706

Cerradura para marco sin galce.

Espesor vidrio 10 mm.

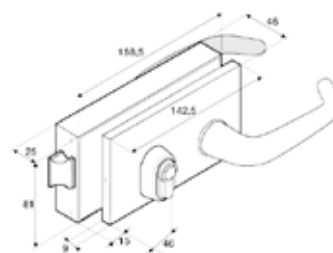

1707

Cerradura para marco sin galce.

Espesor vidrio 10 mm.

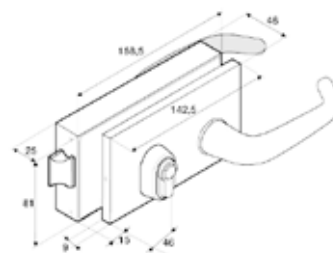

1708

Cerradura para marco sin galce.

Espesor vidrio 10 mm.

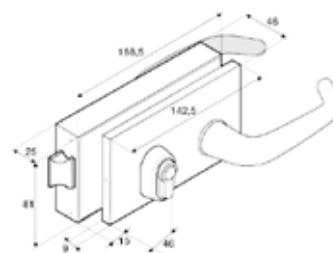

1709

Cerradura para marco sin galce.

Espesor vidrio 10 mm.

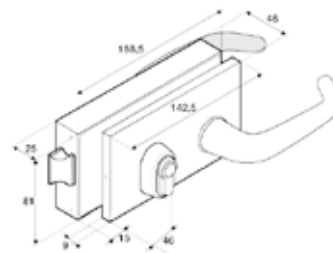

JANO Acabados en: inox brillo - inox satinado

1750
Cerradero para vidrio
con galce.

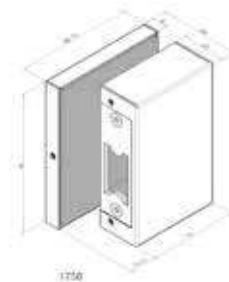

1751
Cerradero para vidrio
sin galce.

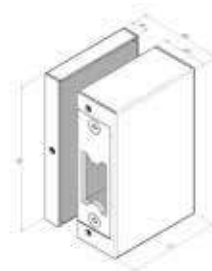

1760
Cerradero picaporte para
carpintería con galce.



1761
Cerradero picaporte con tope
para carpintería con galce.



1762
Cerradero picaporte para
carpintería sin galce.

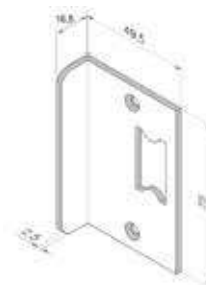

1763
Cerradero para carpintería.



ABATIBLES: Cerraduras vaivén y de barrilete

MEIA / ARES-TER / SCONTO / INTERNO / INDIETRO / JANO / TERRA

TERRA Acabados en: inox brillo - inox satinado

DISPONIBLES PARA VIDRIO DE 12 MM

1013
Suelo rectangular llave 3
puntos de seguridad.
Espesor vidrio 10 mm.



1013/1
Suelo rectangular llave 5
puntos de seguridad.
Espesor vidrio 10 mm.



1013F
Suelo rectangular fijación
mediante taladro llave 3
puntos de seguridad.
Espesor vidrio 10 mm.



1013F/1
Suelo rectangular fijación
mediante taladro llave 5
puntos de seguridad.
Espesor vidrio 10 mm.



1016
Doble central llave 3
puntos de seguridad.
Espesor vidrio 10 mm.



TERRA Acabados en: inox brillo - inox satinado

DISPONIBLES PARA VIDRIO DE 12 MM

1016/1

Doble central llave 5 puntos seguridad.
Espesor vidrio 10 mm.



1025

Suelo redondo llave 3 puntos seguridad.
Espesor vidrio 10 mm.



1025/1

Suelo redondo llave 5 puntos seguridad.
Espesor vidrio 10 mm.



1025F

Suelo redondo fijación mediante taladro llave 3 puntos seguridad.
Espesor vidrio 10 mm.



1025F/1

Suelo redondo fijación mediante taladro llave 5 puntos seguridad.
Espesor vidrio 10 mm.



ABATIBLES: Cerraderos vaivén y de barrilete
 MEIA / ARES-TER / SCONTO / INTERNO / INDIETRO / JANO / TERRA

TERRA Acabados en: inox brillo - inox satinado

DISPONIBLES PARA VIDRIO DE 12 MM

4001
 Simple rectangular para
 empotrar en suelo.
 Espesor vidrio 10 mm.

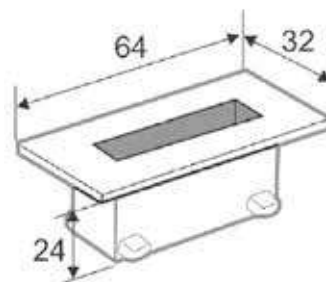

4002
 Doble rectangular para
 empotrar en suelo.
 Espesor vidrio 10 mm.

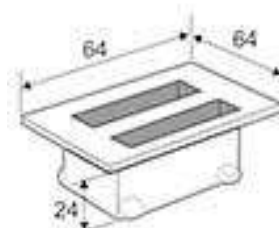

4003
 Simple redondo para
 empotrar en suelo.
 Espesor vidrio 10 mm.

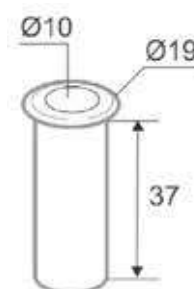

2017
 Simple rectangular vidrio.
 Espesor vidrio 10 mm.

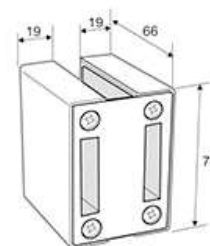

2019
 Simple redondo vidrio.
 Espesor vidrio 10 mm.

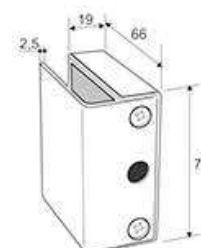

JN

MINI SENCILLO

200 x 150 mm entre taladros.
 Acabado en latón cromado.
 Ø 12 mm.

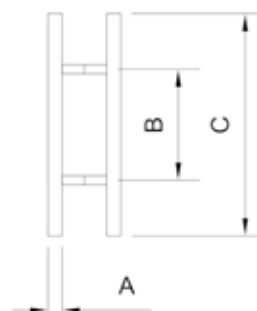

T20x20x250B

T20x20x250S

Tubo de 20 x 20 mm, 250 mm entre taladros.

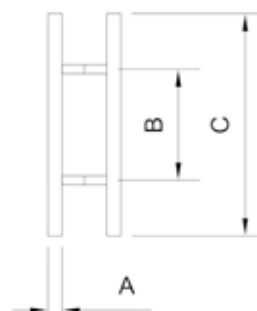

19x300x200B

19x300x200S

Acabado en acero inoxidable.
 Ø 19 mm.

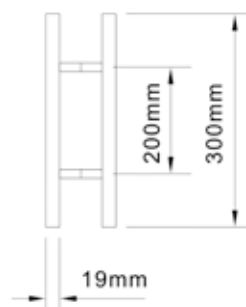

TIPO C: JN19x250

Acabado combi (codos en brillo y satinado) y en satinado.
 Ø 19 mm.

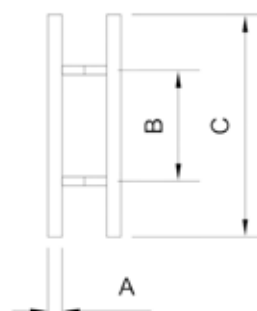

TIPO C: JN32x250

Acabado combi (codos en brillo y satinado).
 Ø 32 mm.

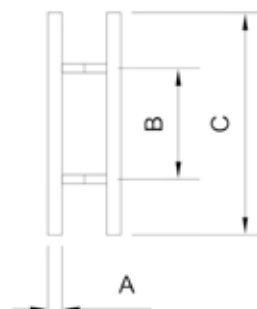

TIRADORES

ABATIBLES: Tiradores

JN / **CIRCUM** / CUBITUS / NORMA / SERIE T

CIRCUM Acabados en: inox brillo - inox satinado

T4730 / T4730S / T4730A

Tirador / 1/2 tirador / Agarradera.
Ø 30.

A: 200 / 250 / 300 mm

B: 400 / 500 / 600 mm



T4758 / T4758S / T4758A

Tirador / 1/2 tirador / Agarradera.
Ø 40.

A: 200 / 250 / 300 mm

B: 300 / 400 / 500 mm

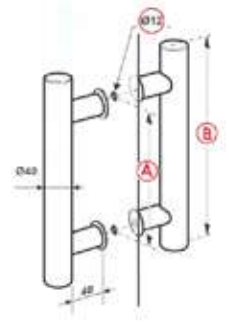

T4758P

Tirador para pegar en
vidrio Ø 40.

A: 200 / 250 / 300 mm

B: 300 / 400 / 500 mm

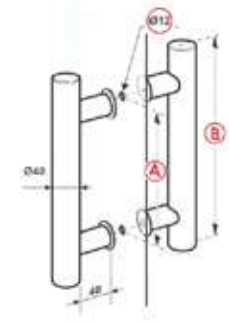

T4760

Juego tirador regulable Ø
20-30.

A: Centro regulable

B: 1200 mm



CIRCUM Acabados en: inox brillo - inox satinado

T4761 / T4761S

Tirador regulable / 1/2 tirador.
Ø 10.

A: Centro regulable
B: 400 / 500 / 600 mm

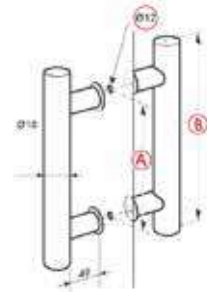

T4765 / T4765S

Tirador regulable / 1/2 tirador.
Ø 20-30.

A: Centro regulable
B: 1200 mm

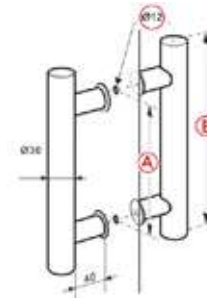

T4767 / T4767S

Tirador regulable / 1/2 tirador.
Ø 20-30.

A: Centro regulable
B: 1200 mm

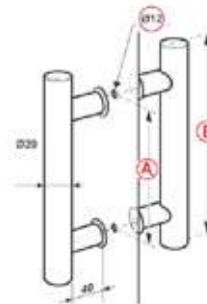

TIRADORES

ABATIBLES: Tiradores

JN / CIRCUM / **CUBITUS** / NORMA / SERIE T



CUBITUS Acabados en: cromo brillo / cromo brillo-metacrilato

10TM

Tornillo manillón.



T4757 / T4757S / T4757A

Juego tirador / 1/2 tirador / Agarradera.

Ø 30.

A: 200 / 250 / 300 mm

B: 230 / 280 / 330 mm

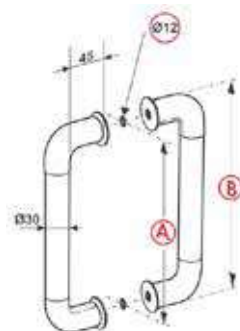

T4790

Juego tirador Ø 30.

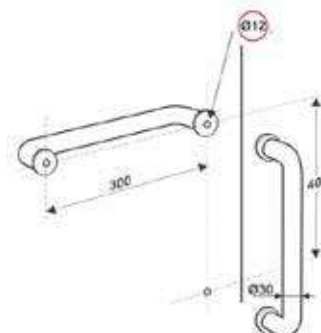

NORMA Acabados en: inox brillo - inox satinado

T4762

Juego tirador Ø 20.

A: 200 / 250 / 300 mm
B: 220 / 270 / 320 mm



T4764

Juego tirador Ø 20.

A: 200 / 250 / 300 mm
B: 350 / 400 / 450 mm



T4766 / T4766S

Tirador regulable / 1/2 tirador.
Ø 20-30.

A: Centro regulable
B: 1200 mm

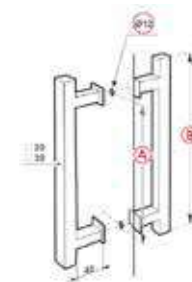

T4768 / T4768S

Tirador regulable / 1/2 tirador.
Ø 20-30.

A: Centro regulable
B: 1200 mm



PLINTOS Y ANTIPÁNICO

PLINTOS Y ANTIPÁNICOS
PLA / PLB / PLBC

PLINTOS Acabados en: inox brillo - inox satinado

PLA
Alto.
Espesor vidrio 10-12 mm.

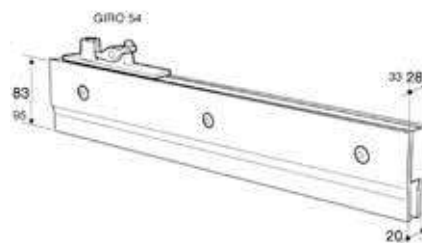

PLB
Bajo.
Espesor vidrio 10-12 mm.

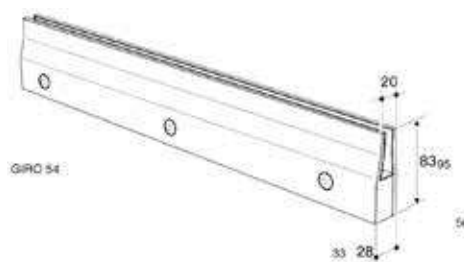

PLBC
Bajo con cerradura.
Espesor vidrio 10-12 mm.

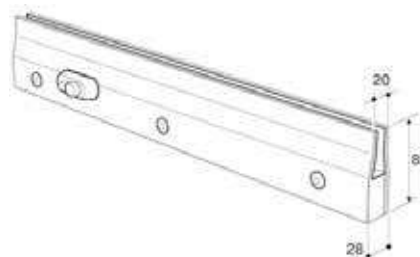

ANTIPÁNICO Acabados en: inox brillo - inox satinado

18001
Cierre lateral con
cerradero para vidrio.
Espesor vidrio 10-12 mm.



SERIE T Acabados en: inox brillo - inox satinado

T1000

Juego tirador de Ø 25.

A: 200 / 250 / 300 mm

B: 300 / 400 / 500 mm

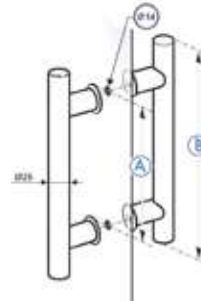

T1001

1/2 tirador de Ø 25.

A: 200 / 250 / 300 mm

B: 300 / 400 / 500 mm

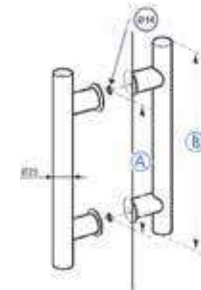

T2000

Juego tirador de Ø 25.

A: 200 / 250 / 300 mm



T2001

1/2 tirador de Ø 25.

A: 200 / 250 / 300 mm

